



ARCHETECH

Turning Dreams into Reality

Issue 51 £4.99



آموزشگاه انعکاس منبع جدیدترین اطلاعات، مقالات و دوره‌های آموزشی دکوراسیون داخلی

 Enekas.Academy

 Enekas.Academy

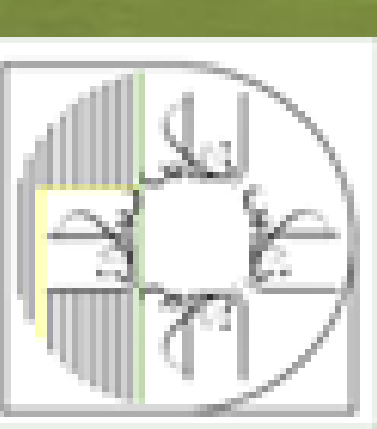
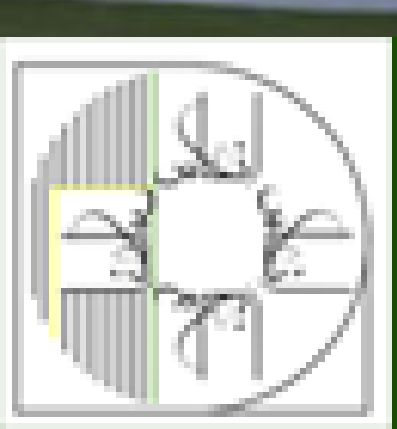



The Perfect Pocket

Nowadays an essential part of your modern day living area.
More space to move around in and more options with furnishings.
Rocket Door Frames fit UK standard door sizes so you can supply
your own for more style and more space at the same time.

The Inexpensive Alternative

From
£119.50
Plus VAT

WARRANTY
12
YEARS
WARRANTY

NEXT DAY
DELIVERY

EXCELLENT
CUSTOMER
SERVICE

Visit: rocketdoorframes.co.uk
0330 998 0617

 **ROCKET**
DOOR FRAMES

آموزشگاه انعکاس منبع جدیدترین اطلاعات، مقالات و دوره‌های آموزشی دکوراسیون داخلی

 Enekas.Academy

 Enekas.Academy

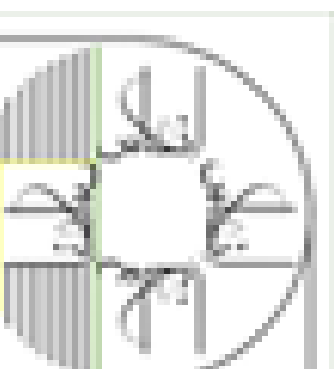
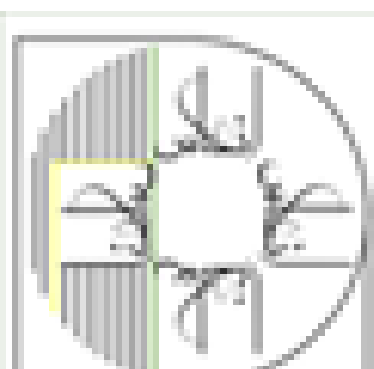

ARCHECH

Turning Dreams into Reality

Main Features

Editor's Choice 10-15

Bathrooms & Kitchens 16-19

Coatings, Sealants & Paints 22-27

Doors, Windows & Fittings 33-43

Education & Healthcare 48-51

Floors & Flooring 54-59

Heating, Ventilation & Insulation 62-68

Interiors & Interior Design 69-81

Landscaping & External Works 84-85

Roofing, Cladding & Façades 90-93

Safety, Security & Fire Protection 96-103

Editorial Highlights 106-111



Case Studies

RIBA - 6-9

The Royal Institute of British Architects (RIBA) is pleased to announce that Sir David Adjaye will receive the 2021 Royal Gold Medal, one of the world's highest honours for architecture

CHRIST & GANTENBEIN - 30-32

Much more than a museum, this versatile project redefines what civic buildings can be

VELUX - 36

Using smart window technology today could help build the homes of tomorrow

IKON - 44-47

Structurally expressive student union creates a "city within a city" on the Daytona Beach campus

IVC - 52-53

Award winning Studio Moods is the off-the-shelf bespoke LVT solution from IVC Commercial, making one-off feature floors more affordable

AIB CORPORATE - 56-57

In the heart of Dublin's central business district, the offices of AIB Corporate Banking have been transformed to embody the company's values, with LVT flooring from IVC used extensively throughout

DILLER SCOFIDIO + RENFRO - 60-61

The United States Olympic & Paralympic Museum has officially opened its doors to the public

9STUDIO DESIGN GROUP - 70-71

The studio space of a designer is the source of thoughts and concepts and a site of imagination. Therefore 9Studio Design Group designed their own studio like the setting for a science fiction movie with a strong sense of prop

STOREY - 78-80

Storey has officially opened its doors to 6 Orsman Road, its latest building located on the banks of Regent's Canal in the creative hub of Haggerston.

BUREAU FRAAI - 82-83

Bureau Fraai and BNLA architecten convert former office spaces into high-end urban lofts

NOMA - 88-89

Latimer, the development arm of Clarion Housing Group, has announced it has completed construction at NOMA, its striking copper-clad development, north of Maida Vale, Westminster

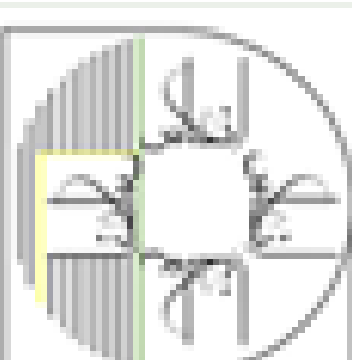
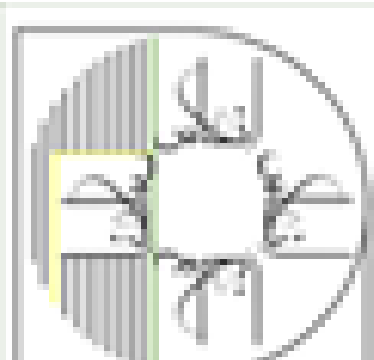
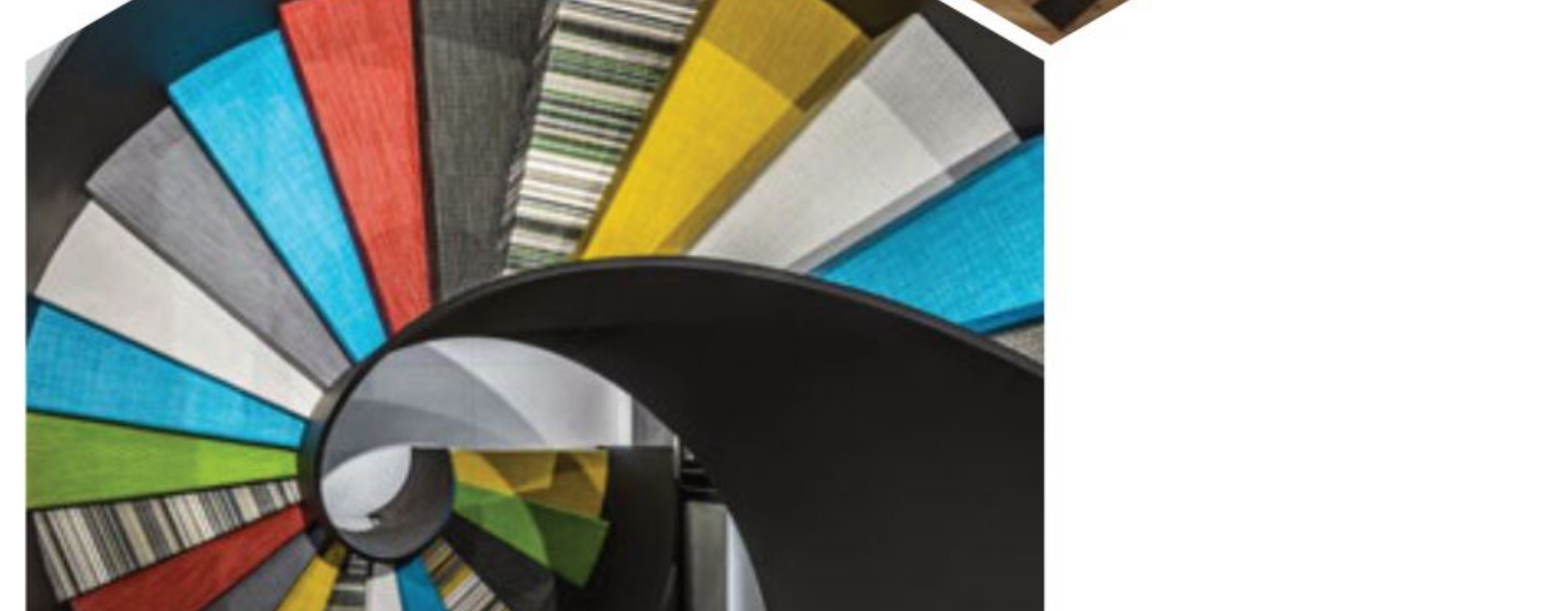
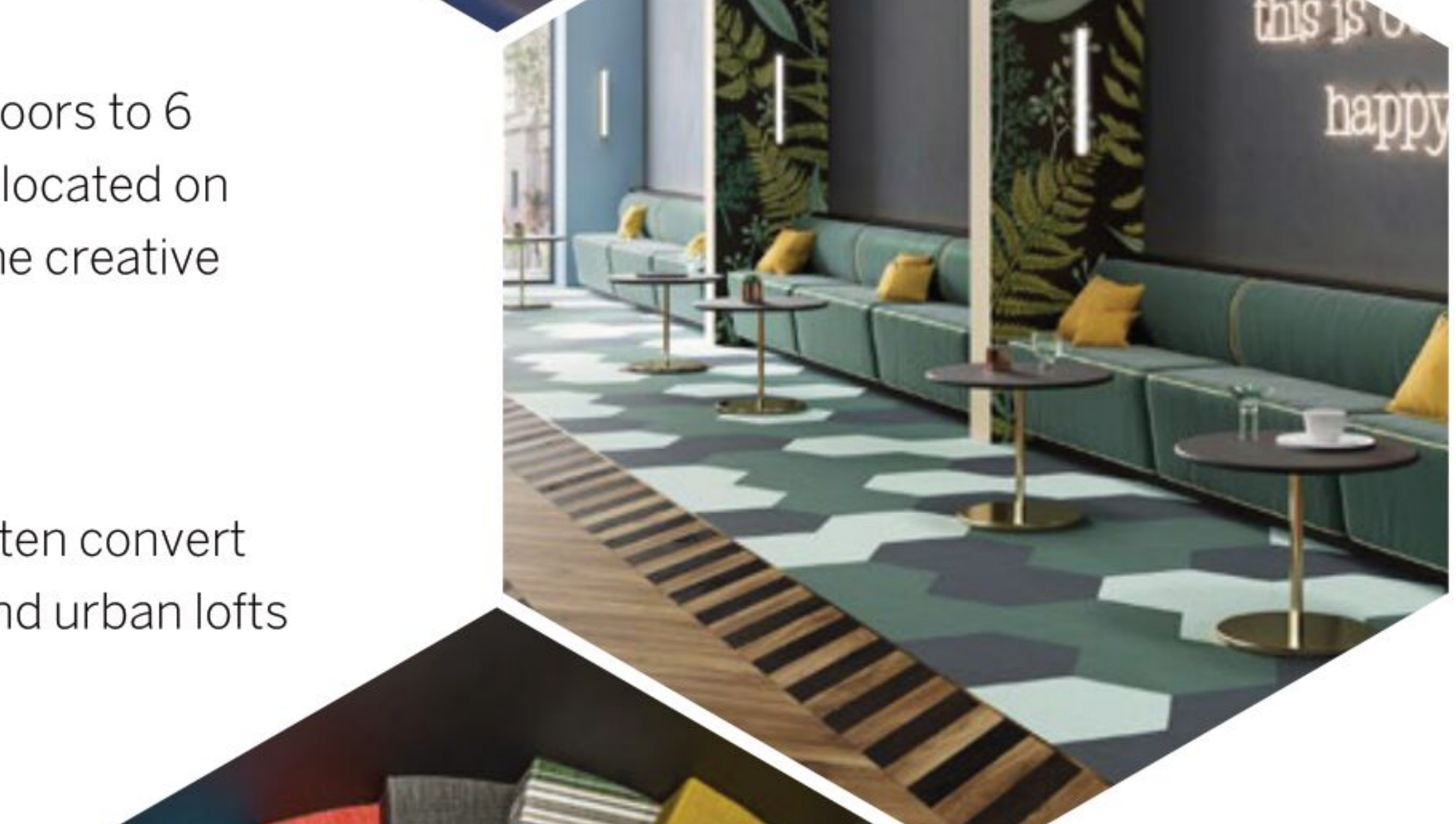

Think wetrooms.

Think systems.

Think Schlüter.

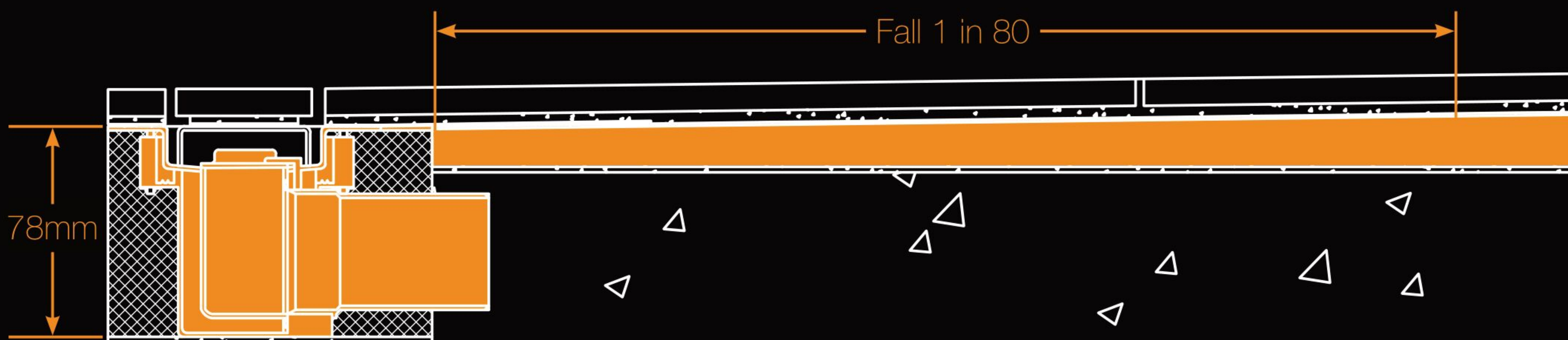

Low height system solutions for level access showers

- ✓ Compliant with BS EN 1253, BS EN 274 & BS 5385
- ✓ Technical and Specification support on & off site
- ✓ Product, system & installation warranties
- ✓ Comprehensive & accredited training



www.lowheightdrain.co.uk

آموزشگاه انعکاس منبع جدیدترین اطلاعات، مقالات و دوره‌های آموزشی دکوراسیون داخلی

 Enekas.Academy

 Enekas.Academy

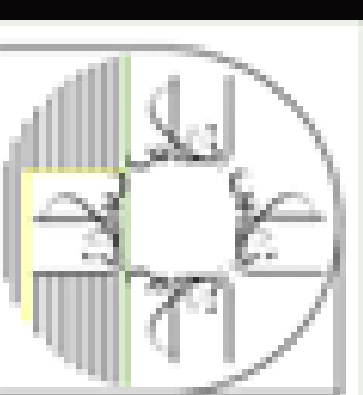
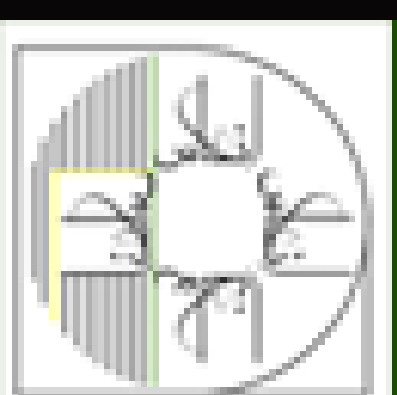

Editor in Chief

Antony Holter - 0203 911 4067
antony@archetech-media.co.uk

Editor

Isabelle Hart - 0203 911 4067
isabelle@archetechmag.co.uk

Sales Director

Steve Hawkins - 0203 907 9165
steve@archetech-media.co.uk

Digital Manager

Jamie Bullock - 01227 936971
jamie@archetech-media.co.uk

Editorial Assistant

Chris Nicholls - 0203 911 4067
chris@archetech-media.co.uk

Business Manager

Josh Holmes - 0203 911 4067
josh@archetech-media.co.uk

Publishing Director

Martin Holmes - 0203 911 4067
martin@archetechmag.co.uk

Accounts

Lauren Davis - 0203 911 4067
lauren@archetechmag.co.uk

Studio Designer

Richard Bland
richard@archetech-media.co.uk

ARCHETECH

Turning Dreams into Reality

The Archetech magazine is an insightful information source for Architects, Architectural Technologists and Interior Designers. We feature lead stories on current projects, industry news and case studies so that our readers have the opportunity to keep up to date in the ever changing world of architecture and design.

Archetech offers architectural and design services to all those who are initiating, planning and implementing projects. Whether you're an interior designer, architect, technologist, developer or builder who is searching for inspiration for the next project, Archetech hosts the latest products, case studies and services to meet those needs.

With sharp editorial content, a cutting-edge design approach and informative written style, our advertisers and readers alike can take confidence in our experience and ability in matching your product to the needs of the marketplace.

Archetech Media Ltd

Tel: 020 3911 4067
www.archetech.org.uk
info@archetechmag.co.uk

Every effort is made to ensure the accuracy and reliability of material published in Archetech Magazine, however, the publishers accept no responsibility for the claims or opinions made by contributors, manufacturers or advertisers. No part of the publication may be reproduced or transmitted in any form or by any means, mechanical, electronic (including printing), recording or stored in any information retrieval system without the express prior written consent of the publisher.

SUBSCRIBE NOW

Digital Edition

SUBSCRIBE TO OUR ONLINE ISSUES FREE OF CHARGE

- Accessible anytime and anywhere on most electronic devices
- Receive the magazine by email as soon as each issue is released
- All issues are stored in an archive, so you can look back across every edition
- Now available on 3 major digital platforms: ISSUU, Joomag and Readly

Printed Edition

- Free of charge for qualifying trade professionals
- Paid subscriptions are available, for non qualifying trade professionals



HAVE YOU GOT A PROJECT YOU ARE PROUD OF?

If you've recently finished a project, conversion or renovation, why not submit it to our Editor in Chief for a chance to be featured in our next issue! Email antony@archetech-media.co.uk with details of your latest project.

Visit: www.archetech.org.uk/subscribe

آموزشگاه انعکاس منبع جدیدترین اطلاعات، مقالات و دوره‌های آموزشی دکوراسیون داخلی

 Enekas.Academy

 Enekas.Academy

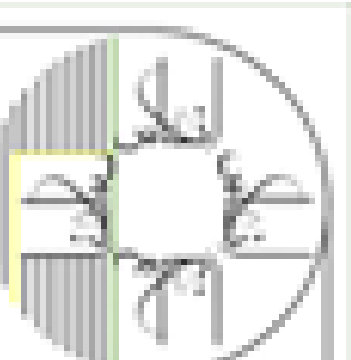
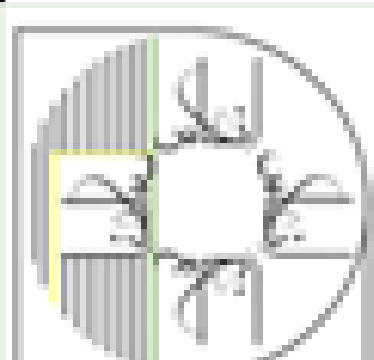



SIR DAVID ADJAYE OBE TO RECEIVE 2021 ROYAL GOLD MEDAL FOR ARCHITECTURE

THE ROYAL INSTITUTE OF BRITISH ARCHITECTS (RIBA) IS PLEASED TO ANNOUNCE THAT SIR DAVID ADJAYE WILL RECEIVE THE 2021 ROYAL GOLD MEDAL, ONE OF THE WORLD'S HIGHEST HONOURS FOR ARCHITECTURE

The Royal Gold Medal is approved personally by Her Majesty The Queen and is given to a person or group of people who have had a significant influence 'either directly or indirectly on the advancement of architecture'.

Sir David Adjaye has achieved international attention for an exceptional body of work over 25 years. Drawing on his cited influences including 'contemporary art, music and science to African art forms and the civic life of cities', his completed projects range from private houses, exhibitions and furniture design, through to major cultural buildings and city masterplans. From the start of his career he has combined practice with teaching in schools of architecture in the UK and the USA, including professorships at the universities of Harvard, Michigan, Pennsylvania and Princeton.



Portrait © Nick Fradkin

آموزشگاه انعکاس منبع جدیدترین اطلاعات، مقالات و دوره‌های آموزشی دکوراسیون داخلی

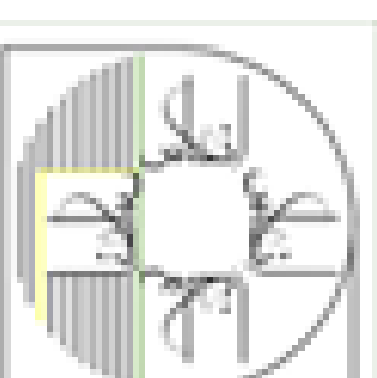
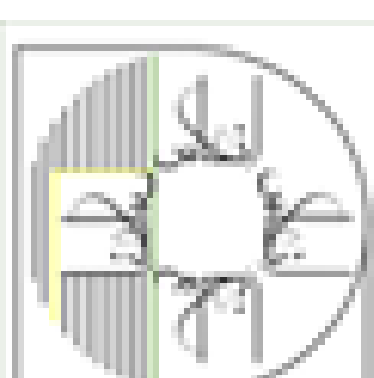

“

Sir David Adjaye has achieved international attention for an exceptional body of work over 25 years



Moscow School of Management

Photo:Aram Arakelyan

His practice, Adjaye Associates, was founded in 2000 and today has studios in Accra, London and New York, with projects across the world.

Adjaye Associates are most well-known for the Smithsonian National Museum of African American History and Culture, in Washington, DC (2016), where they were lead designer of the Freelon Adjaye/Bond SmithGroup. Other completed projects include Ruby City, an art centre in San Antonio, Texas (2019); the Alara Concept Store in Lagos (2016); the Sugar Hill Mixed Use Development (housing, museum, community facilities and offices) in Harlem, New York (2015); the Aishti Foundation, a mixed use retail and arts centre in Beirut, Lebanon (2015); two neighbourhood libraries in Washington, DC (both 2012); the Moscow School of Management Skolkovo in Russia (2010); the Museum of Contemporary Art in Denver, Colorado (2007); the Nobel Peace Centre in Oslo, Norway (2005); Rivington Place arts centre in Hackney, London (2007); and the Idea Stores – two community libraries in London (2004, 2005).



Smithsonian National Museum of African American Arts and Culture, Washington DC

Photo: Alan Karchmer



Aishti Mixed-Use Development, Beirut Photo:ulien Lanoo

آموزشگاه انعکاس منبع جدیدترین اطلاعات، مقالات و دوره‌های آموزشی دکوراسیون داخلی

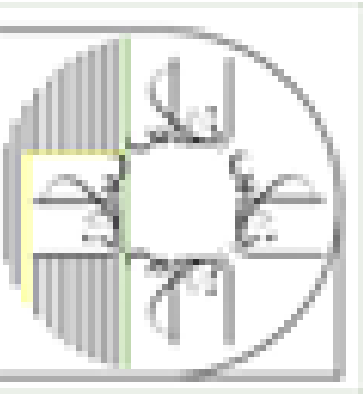

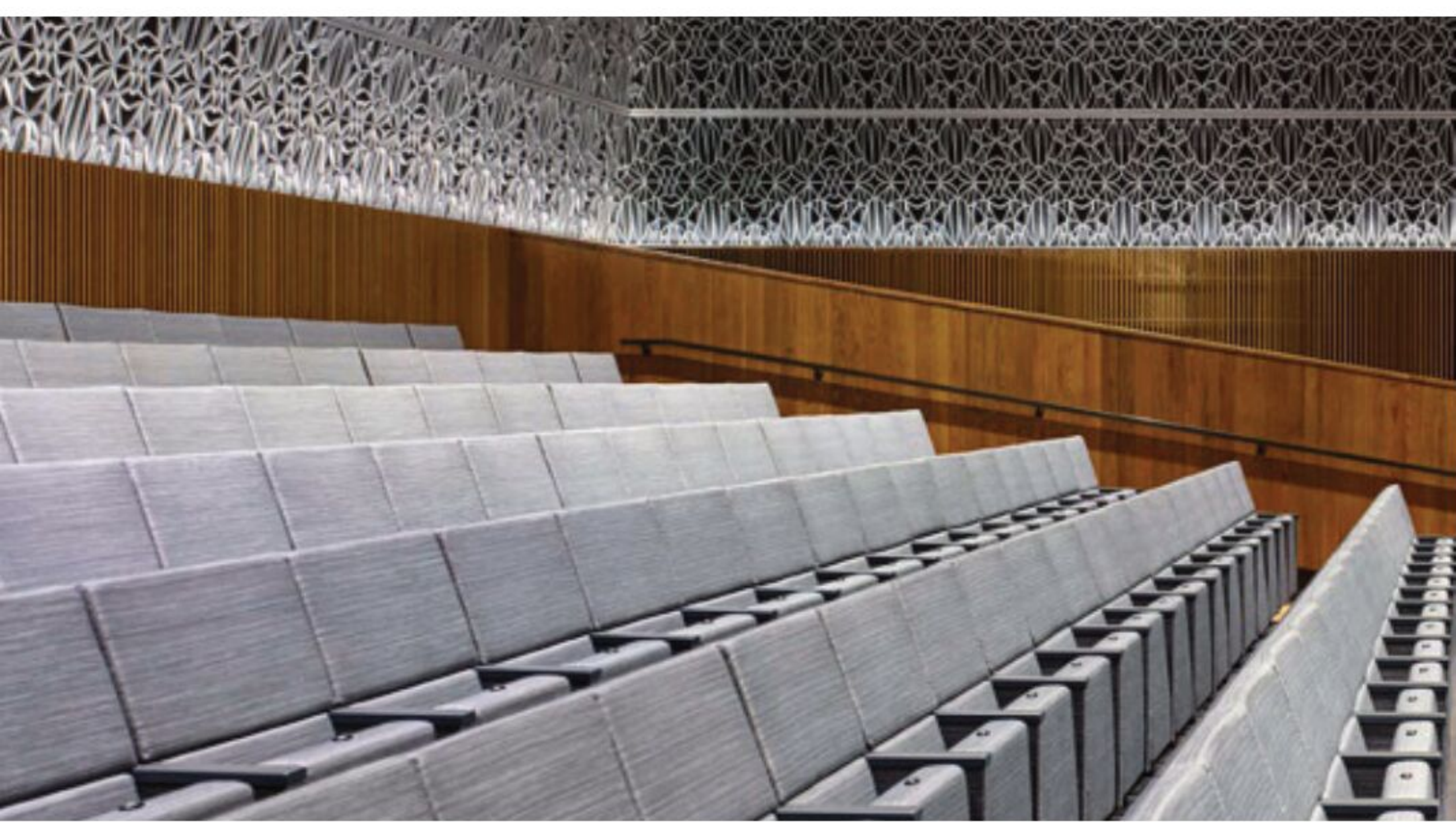

Smithsonian National Museum of African American Arts and Culture - Washington DC

Photo: Alan Karchmer



Specere Kielder, Scotland

Photo: James T M Towill

Current projects include a new home for The Studio Museum in Harlem, New York in collaboration with Cooper Robertson; 130 William, a high-rise residential tower in New York's financial district; the International Finance Corporation (IFC) in Dakar, Senegal; the Princeton University Art Museum in Princeton, New Jersey in collaboration with Cooper Robertson; the George Street Sydney Plaza in Sydney, Australia; The Abrahamic Family House, an interfaith complex in Abu Dhabi; Winter Park Library and Events Center in Winter Park, Florida; the UK Holocaust Memorial and Learning Centre, London led by Adjaye Associates, with Ron Arad Architects as Memorial Architect, and Gustafson Porter + Bowman as Landscape Architect; the Royal Benin Museum in Benin City, Nigeria; the National Cathedral of Ghana in Accra; and the Thabo Mbeki Presidential Library in Johannesburg, South Africa.

On hearing the news that he will receive the Royal Gold Medal in 2021, Sir David Adjaye said:

"It's incredibly humbling and a great honour to have my peers recognise the work I have developed with my team and its contribution to the field over the past 25 years. Architecture, for me, has always been about the creation of beauty to edify all peoples around the world equally and to contribute to the evolution of the craft. The social impact of this discipline has been and will continue to be the guiding force in the experimentation that informs my practice. A heartfelt and sincere moment of gratitude and thanks to all the people who supported the journey to get to this moment."

RIBA President Alan Jones said:

"It was my absolute pleasure and honour to chair the committee and be involved in selecting Sir David Adjaye as the 2021 Royal Gold Medallist."

At every scale, from private homes to major arts centres, one senses David Adjaye's careful consideration of the creative and enriching power of architecture. His work is local and specific and at the same time global and inclusive. Blending history, art and science he creates highly crafted and engaging environments that balance contrasting themes and inspire us all. I believe his both practising and teaching in schools of architecture has significantly enriched his work. His artistic and social vision has created public projects that perfectly demonstrate the civic potential of architecture – fostering empathy, identity and pride.

David's contribution to architecture and design globally is already astounding, and I am excited that we have so much more of it to look forward to."

Sir David Adjaye was knighted in the 2017 New Year Honours for services to architecture, following an OBE in 2007. As a student, he won the 1993 RIBA Bronze Medal for the best design project worldwide; in 2006 his Idea Store Whitechapel was shortlisted for the RIBA Stirling Prize for the best building of the year. He has won RIBA International Awards for the Museum of Contemporary Art, Denver (2008) and the Francis Gregory Library and William. O Lockridge/Bellevue Library in Washington DC (both 2013). The 2021 Royal Gold Medal selection committee, chaired by RIBA President Alan Jones, comprised: architects Lesley Lokko, Dorte Mandrup and last year's Royal Gold Medal recipient Shelley McNamara and structural engineer Professor Hanif Kara.

CITATION ON SIR DAVID ADJAYE BY THE 2021 RIBA HONOURS COMMITTEE:

Through his work as an architect Sir David Adjaye speaks confidently across cultures, disciplines, politics and continents. His body of work is global and local, finely attuned as it reflects and responds to context and community, climate and culture.

The lessons Adjaye learned through his initial series of conceptual and sensuous dwellings set boldly against and within the shifting landscape of central London have been disassembled and reconfigured as he has realised wider, civic public and social spaces of cities across the world. Listening to clients and users and often working with artists, Adjaye's work is contradictory and yet coherent, contrasting and courageous, setting up and balancing elegance and grit, weightlessness and weight, dark and light.



Bernie Grant Art Centre, London

Photo: Assen Emilov

Adjaye has combined practice and teaching in schools of architecture around the world and championed civic representation through public discourse. He is dedicated to communicating and creating architecture that is both personal and inspired by culture and the stories of people's lives, realising places that offer new layers of empathy, experience and engagement.

His work reveals a core belief in the generative power of architecture. In a world that has become polarised he brings politics, art and science together with architecture, as he works to create a better future. The Smithsonian National Museum of African American History and Culture in Washington DC united his many architectural and cultural agendas and expressed the role architecture can play in pluralism.

Adjaye is a singular and timely talent and a strong reminder of the insightful and integrative role of the architect.

For more information on the Royal Gold Medal, which was first awarded in 1848, go to: www.architecture.com/awards-and-competitions-landing-page/awards/royal-gold-medal



David Adjaye

Photo: Chris Schwagga

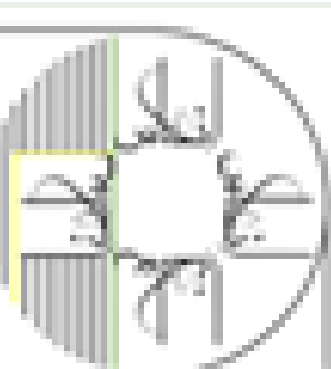

SCHÖCK CAD/BIM LIBRARY NOW INCLUDES ISOKORB, BOLE AND DORN

As a leading international supplier of load-bearing thermal insulation products and reinforcement technology solutions, Schöck continues to optimise its digital portfolio service for planners; with the focus very much on improved digital workflow using web applications and BIM objects. In addition to the Isokorb thermal break range – which offers three distinct levels of detailing – the updated CAD/BIM library also now offers the Bole punching shear reinforcement range and Dorn single-shear and heavy duty dowels. All in many common 2D and 3D formats. The BIM-compatible IFC files of these varied Schöck products can be used in all common BIM planning software such as Revit, Archicad or Tekla Structures. Digital product information is easily accessible for all those involved from planning to the construction site and can be efficiently integrated in a continuous, networked process.

The Schöck CAD-Service platform is free of charge and available by visiting: <https://cad.schoeck.co.uk/?mandant=GB&CUL=en-GB>

For the full range of Schöck product solutions contact the company on 01865 290 890 or visit the website at www.schoeck.co.uk



Replacement Balustrade



A great many character or period properties have stone balustrade incorporated into their design. These balustrades make a large visual impact, but they also have a practical purpose as barriers and screens.



A common cause for the demise of a balustrade is the presence of water. Many original balustrades were made from artificial stonework such as Roman Cement, Concrete and Stucco. These were often reinforced with iron or mild steel bars which rust and expand when exposed to water over a long period.



Other balustrades were made of natural stone such as Portland Stone or Bath Stone. While these types of balustrade do not suffer from 'blown' reinforcing, they do have a finite life span and the surface of stonework will often delaminate or form powdery patches.

Kent Balusters

Tel: 01634 711617
Email: info@kentbalusters.co.uk
Web: www.kentbalusters.co.uk

2020 TTA AWARDS CELEBRATE THE MOST SUCCESSFUL TILING PROJECTS

The 2020 TTA Awards have been celebrated at an online event this year. This did not in any way detract from the achievement of all the winners and finalists. Kyran Bracken MBE did a great job as host once again.



This year's Gold sponsors were: Banks & Lloyd, Jackoboard, Mapei, Norcros Adhesives, Palace Chemicals, PCS, Shackerley (Holdings) Group Ltd., Tilemaster Adhesives, Trimline Group, UltraTileFix and Verona. One of the key categories in which Awards were presented was 'Best Commercial Project – Large (over 250m²)'. This went to ARDEX UK & Dyson-Briggs & Sons for their work on the Pool Complex at Butlins, Bognor Regis. The project Architect was PWP Architects, Kier were the main contractor and Dyson Briggs were the sub-contract tiling specialist. ARDEX were contacted due to their expertise in pool and wet leisure installations.

The Tile Association
0300 365 8453
www.tiles.org.uk

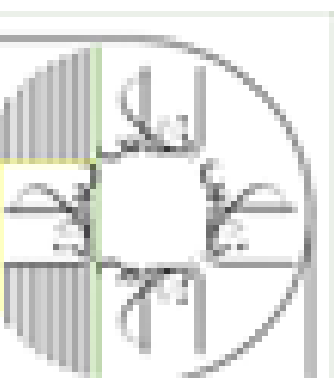
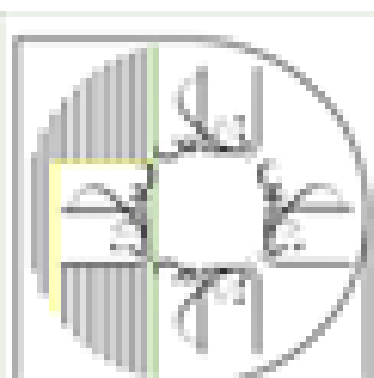

INDUSTRY CALL FOR GOVERNMENT TO PRIORITISE DATA STANDARDISATION IN PLANNING SYSTEM REFORMS

Leading figures from across the property industry discussed the priorities that must be considered as part of the proposed reforms of England's planning system during a virtual event that focused on the Government's Planning for the Future consultation.



Representatives, including those from MHCLG, Atkins, RICS, ABI and BRE, welcomed the focus on taking an 'analogue' service to 'digital', to provide greater collaboration, standardisation of processes, digitisation of data to support plan making and community engagement in planning applications and decisions.

Alex Wrottesley, managing director of Landmark Information's Environment & Mapping division said, "Collaboration is fundamental to how we do things in a data economy, and data and PropTech are at the heart of these reforms; by working in collaboration we will modernise and streamline the process so we can build the homes we need, where we need them, and of the quality that is needed, whilst considering the environment around us."

For further information visit www.landmark.co.uk

THE LIGHT GAUGE STEEL SOLUTION

Simpson Strong-Tie is all set to provide the steel frame construction industry with performance tested connectors and fixings with the release of their 2021 Connectors for Light Gauge Steel catalogue - created for suppliers, architects, engineers, erectors and contractors alike.



Alongside the ever popular TJC Jack Truss and Rafter Connector, an on-site adjustable angle bracket, HTT5 Tension Ties and the Quik Drive collated fastening system sit brand new product innovations:

- The LGSSC Splicing Clip connects over-sail LGS studs to the primary structure
- The RCKW Parapet Wall Bracket resists an over-turning moment at the base of exterior knee-walls and parapets
- X1214 screws are capable of drilling through 5mm steel and suitable for 450 grade hardened steel.
- X1224 screws are capable of drilling through 12.5mm steel and suitable for fixing to hot rolled steel sections.

"Our range of connectors can assist on-site installation and ensure projects are completed on time and to your specification." Explains Sales Manager Keith Lister. "Our dedicated technical support team are available daily to help you select your solution."

Download the catalogue at www.strongtie.co.uk.

KINESURF+ - A SHOWER TRAY FOR EVERY BATHROOM

The Kinedo Kinesurf+ range from Saniflo's is one of the most comprehensive tray ranges. Manufactured in France it is available in a range of six colours – white, black, anthracite, grey, taupe and sable – and three shapes; square, quadrant and rectangular. Sizes from 800mm up to 1800mm.



The lightweight, 40mm thick tray range can be installed flat, recessed or raised on feet and features a fine textured anti-slip surface. The metal drain grill is self-coloured match the tray colour and the waste position on some models can be either centred on the length of the tray or the width.

The mid-priced Kinesurf+ is finished with a Biocryl surface and Biotec high density polymer reinforcement to provide strength and durability and has a standard 10 year warranty.

For information on special display and stocking deals, please contact the sales team at Kinedo or Saniflo on sales@saniflo.co.uk.

SIMPSON Strong-Tie

Our widest range of Light Gauge Steel products to date, designed to make life simpler for builders, engineers and architects.

Pick up your copy of our brand NEW Connectors and Fasteners for Light Gauge Steel 2021 Catalogue. Building Safer, Stronger Structures.

Connect with us: 01827 255600 | www.strongtie.co.uk | [Twitter](#) [Facebook](#) [Instagram](#) [LinkedIn](#) [YouTube](#) @strongtieUK

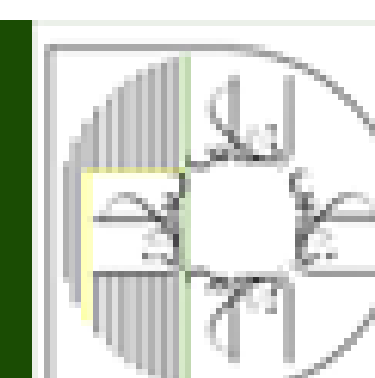
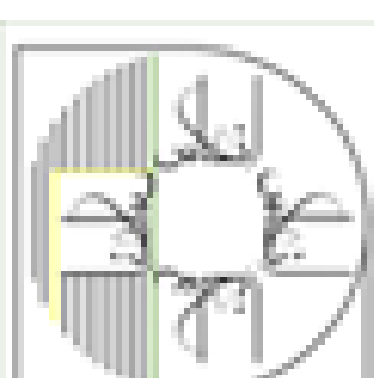



DEVELOPING A COMPLIANT, SAFE AND AESTHETICALLY APPEALING BUILDING ENVELOPES

Like so many industries 2020 has been a tough year for construction but we need to learn lessons from the past and emerge with improved products and services to produce better, more resilient, and safer buildings. Heath Hindmarch Chairman of PSP Group considers the challenges of specifying building envelopes.

Building envelopes are quite rightly coming under greater scrutiny than ever before – the external facade has multiple roles to fulfil and therefore even greater consideration has to be given to not only make them aesthetically appealing but safe and compliant.

All buildings must meet Building Regulations and should provide a controlled internal environment that is protected from the

variable and uncontrollable external climate. The type of facade will depend on the height and scale of the building together with its intended use – all are crucial factors in specification decisions. With pressure to enhance safety and reduce operational energy consumption now being placed on the construction industry, specifying the building envelope is complex.

In addition to satisfying the functional requirements, aesthetics is also an important part of the equation to ensure the appearance of a building reflects the surrounding environment and meets any local planning requirements together with the architectural design intent. Building designers are now demanding more aesthetic elements – an architectural approach is now an essential part of the mix, as well as a quality product that can be used across a complex array of building typologies.

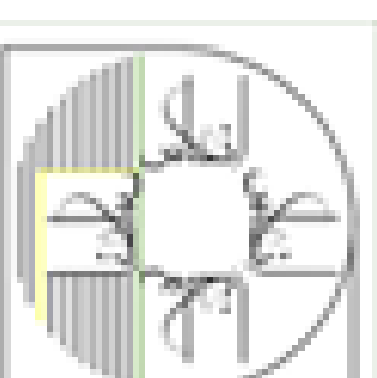
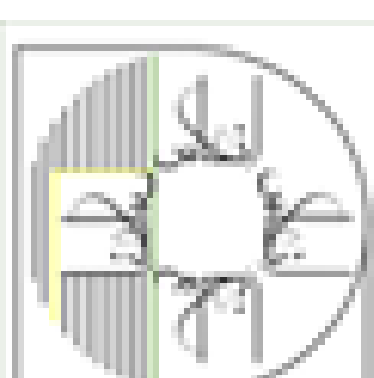

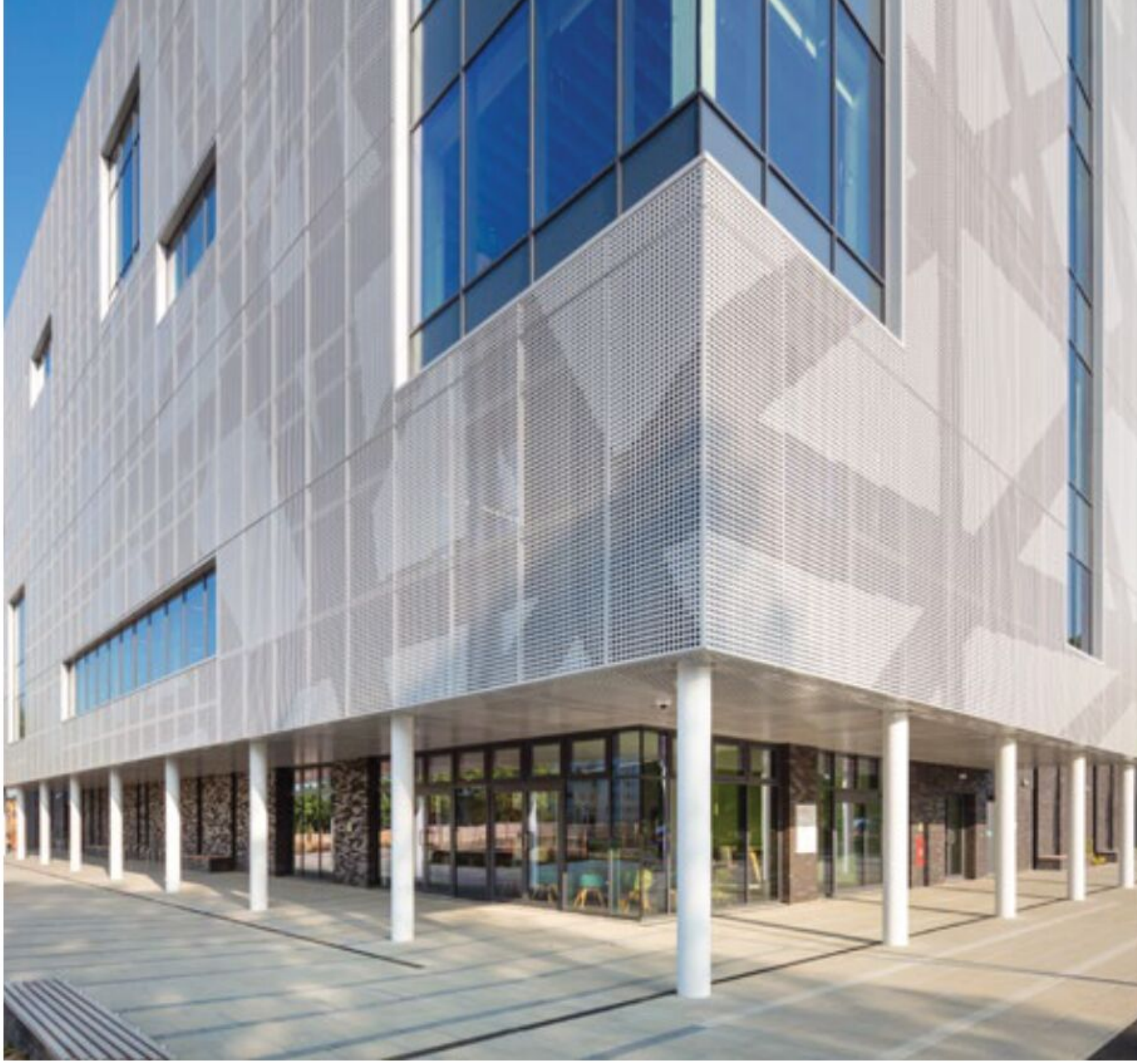

The new sports complex at Solent University was constructed by Morgan Sindall using PSP's bespoke fabrications

There have been huge technical advancements in facade and cladding solutions in recent years and PSP Group has been at the forefront of many of these developments. As one of the UK's leading providers of rainscreen systems, metal fabrications and bespoke full envelope solutions – quality is at the core of our innovative operation. We invest in the latest technology and cutting-edge software to optimise Design for Manufacture and Assembly (DfMA) protocols to eliminate waste and value engineer our products to offer practical yet aesthetically appealing solutions.

PSP's manufacturing processes take place in our precision-controlled advanced factories. Our architectural and aluminium

manufacturing teams also collaborate with our experienced designers to maintain premium quality throughout all processes, from design to manufacture, to transportation of finished systems.

We acknowledge that all clients require bespoke solutions, tailored to individual needs and this is our strength. By offering design as well as manufacturing services for the entire facade, are we able to minimise risk by obtaining full control and responsibility from point of design. We specialise in designing and fabricating steel and aluminium but also offer other metals and composite materials.

Reasons for Specifying Steel or Aluminium

- **Aesthetics** – large range of finishes and precise colours
- **Safety** – A1 & A2 Fire Rated systems
- **Efficiency** – rigorous manufacturing standards to support airtight building envelopes
- **Resilience** – can withstand the rigors of extreme weather conditions
- **Durability** - aluminium and steel systems offer an extended lifespan

FULL SERVICE APPROACH

PSP offer a range of rainscreen cladding, rainwater goods, ventilation systems, solar shading, flashings, pressings and facade support systems. Their expertise extends to the design, manufacture and supply of specialist fabrications to meet individual needs. During the final construction phase, add-ons such as curtain walling, windows and doors can also be supplied – to complete the package.

To find out more about PSP Architectural's design and manufacturing capabilities together with their extensive range of products and services go to: www.pspuk.com

Colour changing façade at Camden's Parliament Hill School was supplied by PSP Architectural - Image Courtesy of GSS Architecture



“

Building envelopes are quite rightly coming under greater scrutiny than ever before

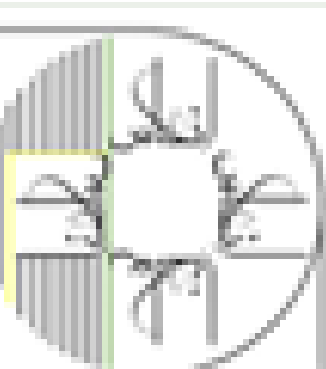



SCHÖCK ISOKORB FOR SEAFRONT PASSIVE HOUSE AWARD WINNER

Seaton Beach Apartments in Devon is the first UK multi-residential development to be certified as passive house plus. Some claim that passive house standard is easier to achieve with simpler, box-like forms, resulting in finished buildings being aesthetically limited – but this is certainly not the case here. A little design ingenuity and the use of Schöck Isokorb thermal breaks, has enabled generous sea-facing balconies with sweeping curves to create a striking finish.

Seaton may be a traditional Devon seaside resort town, but there is nothing traditional about the eye-catching new passive house development right on the seafront. Seaton Beach Apartments is an innovative, award-winning, new development of seven luxury two-bedroom beachfront apartments, complete with a three bedroom penthouse – and is the first multi-residential development in the UK to be certified as passive house plus. Which means it is not only able to meet the ultra-low energy fabric requirement, but also generates renewable energy.

The project can also boast 'best sustainable residential development in the UK' from the International Property Awards.

Initially though, the original architectural design was not to passive house standard. However, the developer recognised that the south-facing orientation and form factor would make it possible to reach the necessary standard. Architects Gale and Snowden, who have helped stimulate the trend for larger scale passive house projects in the region, were brought in at this point to develop the initial detailed designs and oversee the construction. The ground floor is concrete, with a monolithic clay block construction used from the first to third floors and timber frame for the penthouse. Combined with high-performance external render and internal plaster, the result is an entirely mineral hygroscopic wall build-up, which helps to regulate humidity and provide a healthy and comfortable internal environment.

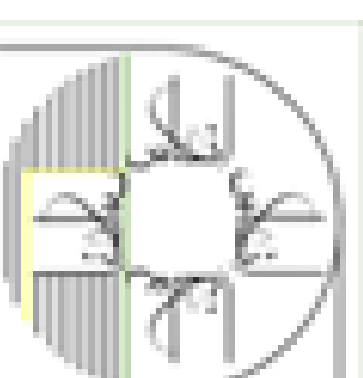
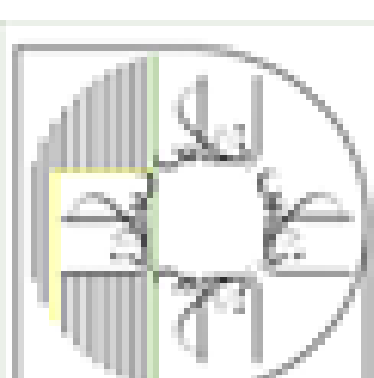

“

The project can also boast ‘best sustainable residential development in the UK’ from the International Property Awards.

USES 90% LESS ENERGY THAN A TYPICAL NEW BUILD

Other features of the construction include low electromagnetic field wiring arrangements and a highly efficient mechanical ventilation system with heat recovery. Complete with an exhaust air heat pump for hot water supply. An array of PV panels on the roof yield an annual 14,234 kWh, resulting in the building generating more energy than it uses. There is a constant supply of silently circulated filtered fresh air within the triple glazed, airtight construction. And 90 per cent less energy used than in a typical new build. All factors which have contributed to the building achieving the stringent passive house plus target.

Passive house standard is easier to achieve with simpler, box-like forms and finished buildings are often considered aesthetically limited and rather prosaic. However, with Seaton Beach Apartments, a little design ingenuity and the use of Schöck Isokorb thermally broken balcony connectors defies this notion. The potentially unexciting building now features large sea-facing balconies with generous curves. The detailing of these balconies is critical though, if thermal bridging is to be minimised and the building’s energy performance not compromised.

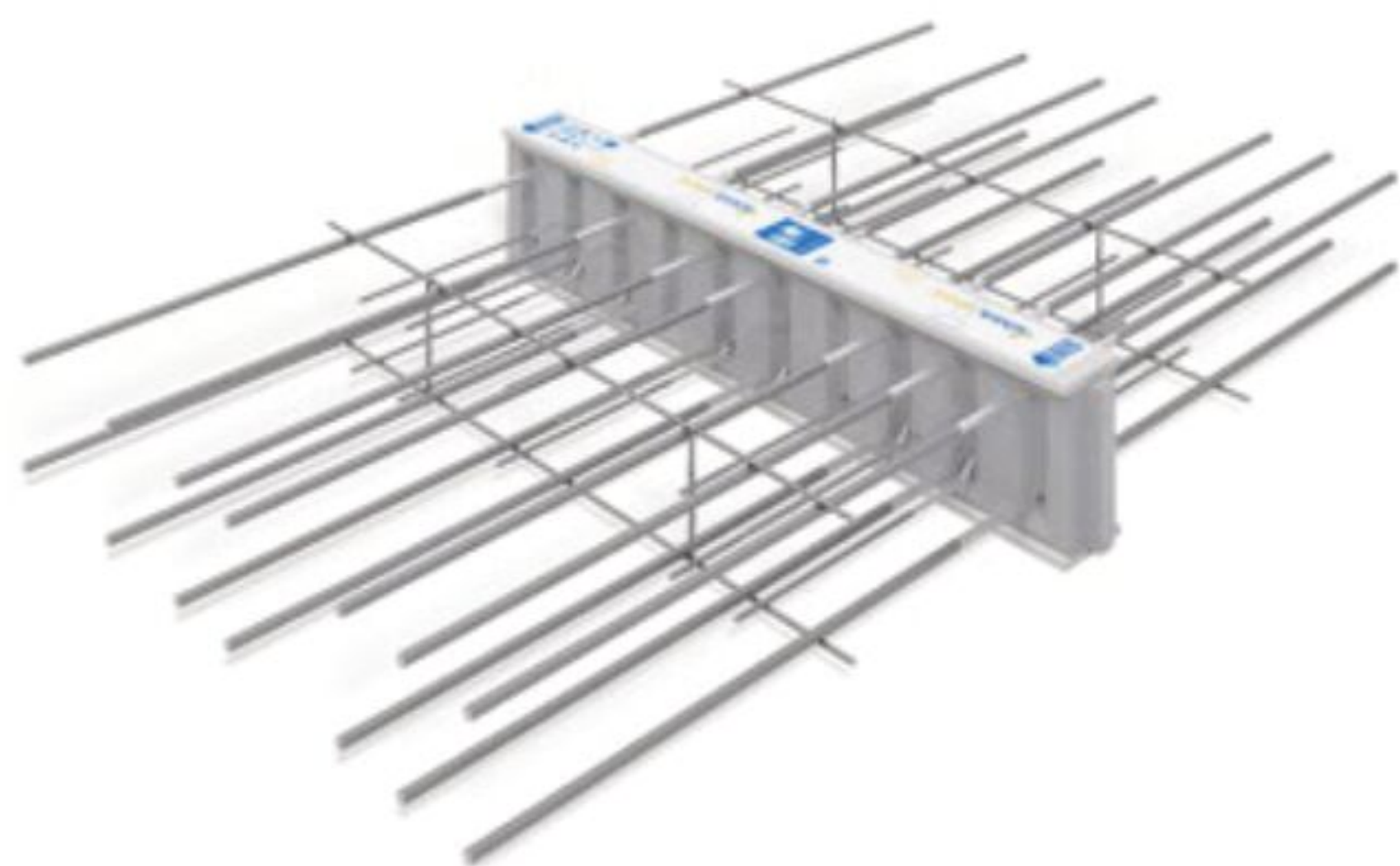

THE ISOKORB IS A TECHNICALLY ADVANCED SOLUTION

Schöck Isokorb thermal breaks are installed where the balconies meet the clay block structure, as ineffectual insulation at these cantilever connectivity points will result in local heat loss. This means more energy is required to maintain the building’s internal temperature. Low internal surface temperatures around the thermal bridge can also cause condensation, leading to structural integrity problems with absorbent insulation products and the potentially serious occurrence of mould growth. The Schöck Isokorb is one of the most technically advanced countermeasures against thermal bridging. It not only thermally separates components from one another, but acts in a structural design capacity as well. The product type used here has an innovative HTE Compact compression module made of high-density micro-fibre reinforced concrete and transfers both negative moments and positive shear forces with cantilever balconies, or positive field moments combined with shear forces.

ENORMOUS FREEDOM OF DESIGN

As the leading international supplier of structural thermal breaks, Schöck is able to offer planners complete construction dependability and almost limitless freedom of design with the options available in its Isokorb product range. There are solutions for concrete-to-concrete, concrete-to-steel, steel-to-steel, a thermally insulating connection for reinforced concrete walls – and even a maintenance free alternative to wrapped parapets. The temperature factor used to indicate condensation risk (fRSI) which must be greater than, or equal to, 0.75 for residential buildings, is easily met by incorporating the Isokorb. All products meet full compliance with the relevant UK building regulations and the NHBC. They also offer LABC Registration and have independent BBA Certification.

For a free copy of the Schöck Thermal Bridging Guide; the Schöck Specifiers Guide or to view the range of downloadable software, contact Schöck on 01865 290 890 or visit the website at www.schoeck.co.uk

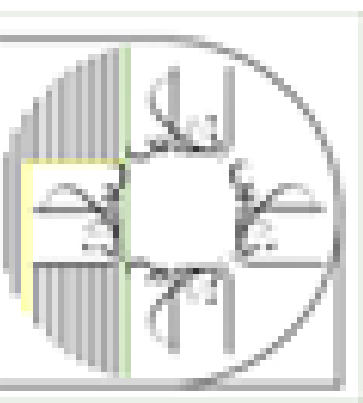

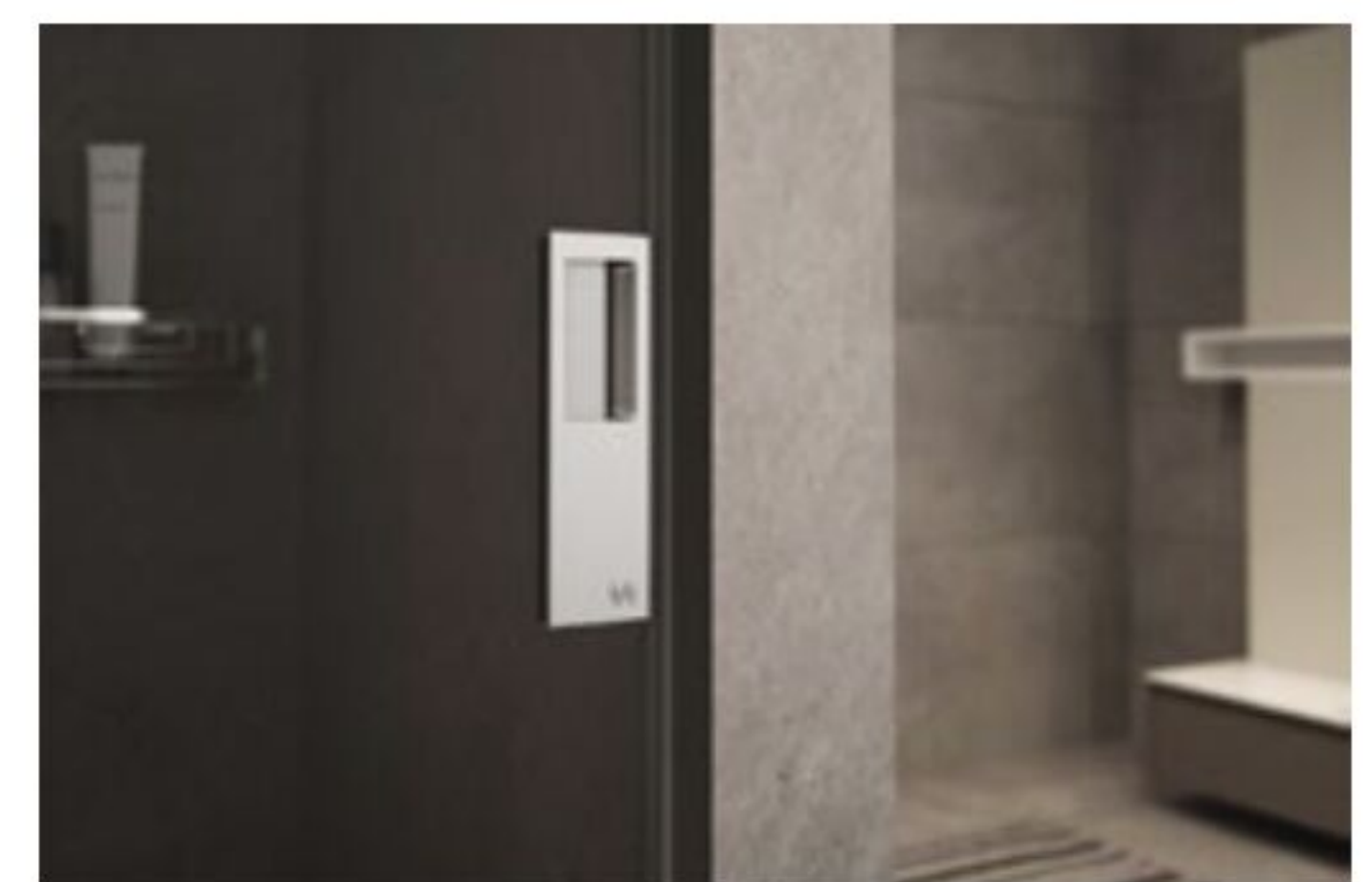
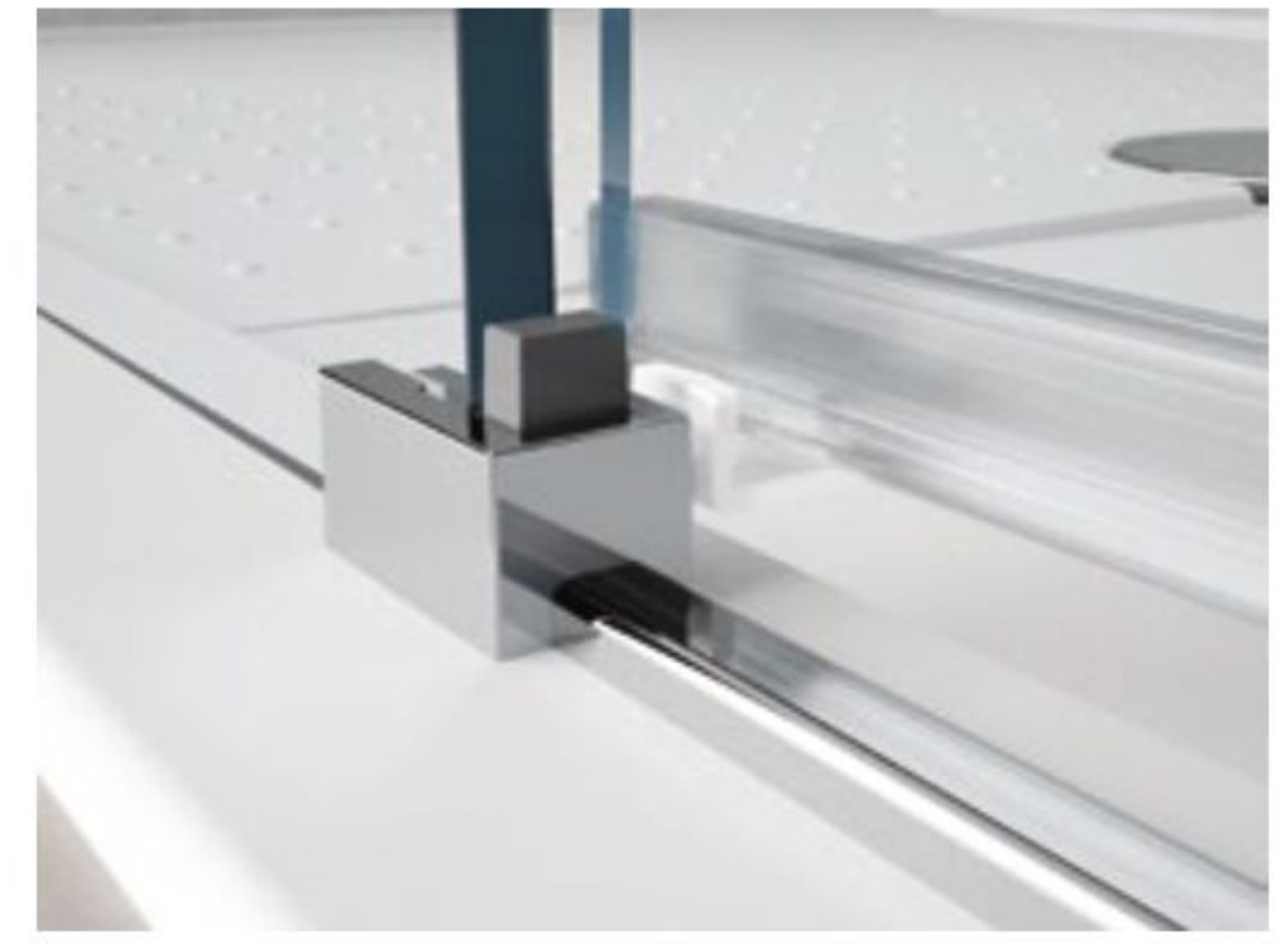

DISCOVER THE BEAUTY FROM WITHIN

DISCOVER OPERA BY NOVELLINI

Beautiful inside and out - Opera, the latest innovation from premium Italian bathroom specialist Novellini, delivers both in terms of aesthetics and functionality.

Designed by Marco Pellici and manufactured in Italy, at first glance Opera, from Novellini, might look like any other enclosure on the market but there's more to it than meets the eye.

Inspired by the industrial trend, not only does this chic model feature a distinctive handle cut into the glass, created to provide more generous access to the shower space, but what really makes it stand out is what's actually hidden from view.

Recognising that functionality is as important as design, Novellini has developed a sophisticated system that allows the door to open and close softly. This mechanism is cleverly concealed inside

the profile of the door, making the enclosure look as good on the inside as it does on the outside.

Available in matt black and matt white finishes, Opera meets demand for the current monochrome interiors style, making it the ideal choice for any modern bathroom. Give your project the edge with Opera by Novellini.

KEY FEATURES

- Silent, soft-touch open and close operation
- 8mm crystal clear glass
- Chrome, matt black and matt white frame finishes
- Clear and printed glass options

Contact details: Get in touch today: Call 01727-229922

Email info-uk@novellini.com or visit www.novellini.co.uk

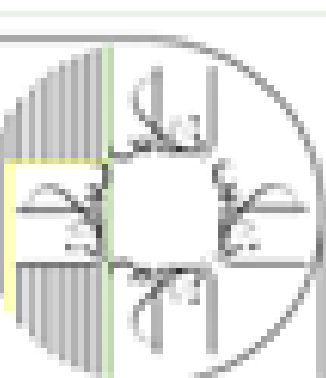



NOVELLINI

YOUNG 2.0 2GS TOTAL BLACK



MINIMALISM AND CLEAN LINES

With a whole host of exciting product features, such as showering height of 2000mm, through to the minimal matt black, matt white or polished chrome profiling giving the enclosure a sleek and luxurious look. Coupled with the rise and fall door mechanism and the versatility to be installed on a shower tray or tiled floor, the **Young** collection gives you a multitude of showering options and fantastic value for money. Combine this with our **Novosolid** stone shower tray or Novellini **Wetroom** for the total solution.



Designed and
manufactured
in **MANTOVA**

FOLLOW US



Discover the
Black & White

آموزشگاه انعکاس منبع جدیدترین اطلاعات، مقالات و دوره‌های آموزشی دکوراسیون داخلی

 Enekas.Academy

 Enekas.Academy

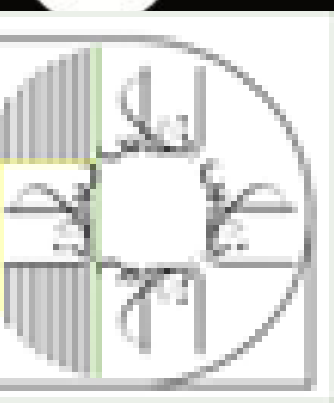



BESPOKE BIRCH PLY KITCHENS & FURNITURE

When Matt Antrobus made his first birch ply & Formica table, he never imagined that over a decade later the material would become the go-to choice for most of his customers, and that his flourishing bespoke furniture business would be using birch plywood for the majority of its work. But sitting in his workshop in Bristol, he says, "We love birch ply, it's beautiful, versatile & sustainable and ticks all the boxes our clients want when looking for a stand-out piece of handmade furniture."

Twelve years later Matt regularly gets commissions for entire bespoke kitchens. "We pride ourselves on the quality and beauty of our finished products" says Matt. "Everyone loves the visible ply edge, and we either laminate the face with Formica, or leave it 'naked' for staining or lacquering." Matt continues, "However, we also appreciate that some clients need to keep costs down whilst still wanting to achieve a bespoke look, so we also make 'hybrid' kitchens which combine our doors and drawer fronts with off-the-shelf carcasses from suppliers such as Ikea and Howdens."

The business now also gets commissions for wardrobes, desks, benches and book shelves and, always wanting to expand their range, they have recently developed a unique pegboard system which has compatibility with most off-the-shelf accessories.

Always wanting to keep ahead of the game, Matt is now also working with other materials including bamboo, oak faced ply, and Valchromat, which is available in a variety of colours. "A couple of years ago we invested in a high end CNC machine", explains Matt, "and this has enabled us to speed up production as well as

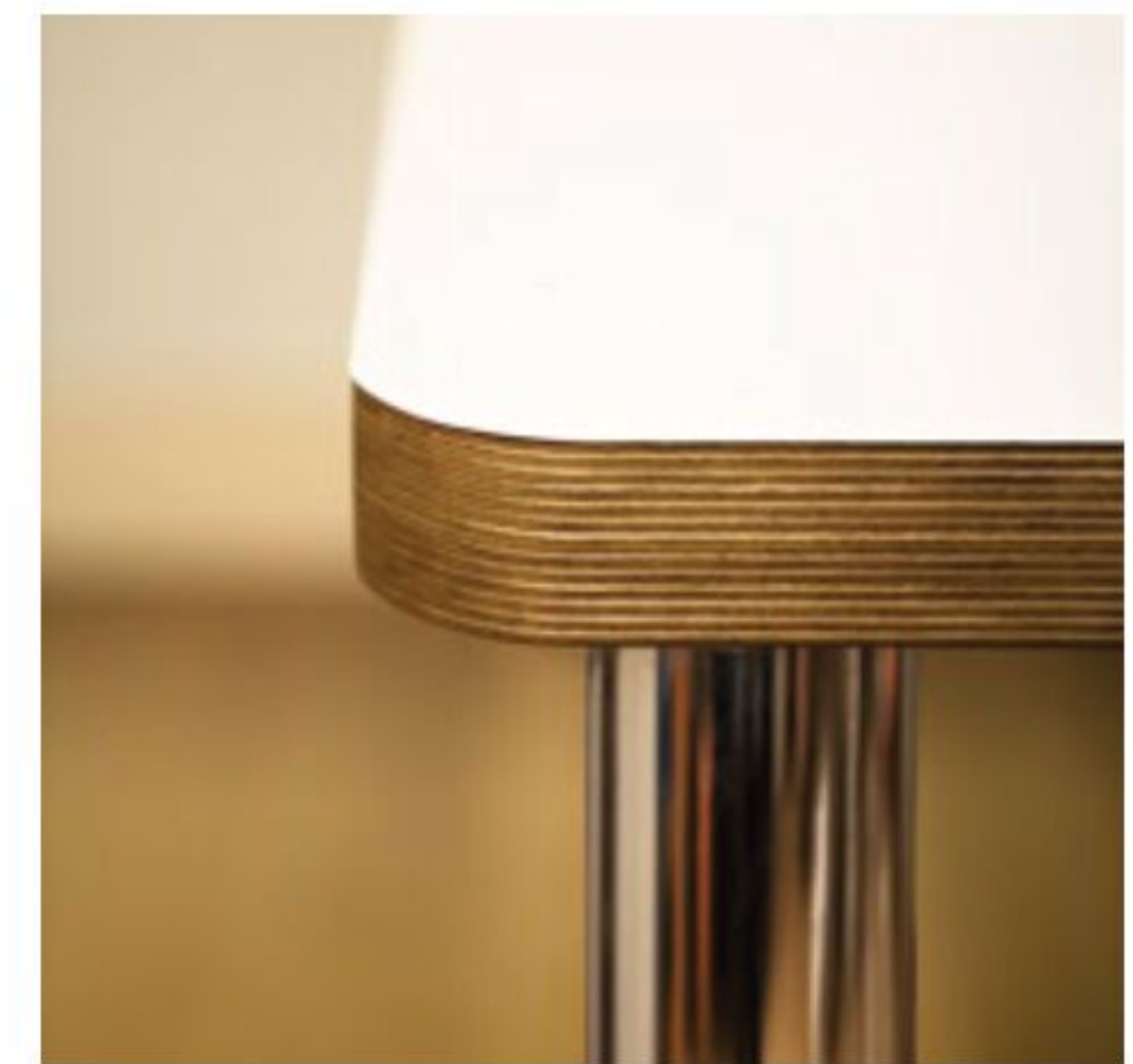

streamlining & improving our processes, as it can easily import designs from supplied drawings."

The company works closely with Architects, Interior Designers & Kitchen Installers to fulfil their customers dreams. Recent clients include Greenhouse PR, Hook Mason Architects, Partyecture, Burgess Architects and Oramaa Lawrence Architects. "We also worked with Russell Norman to make the cafe-style table tops for Mishkins, in London", says Matt.

The business has now been established for over 12 years and it supplies bespoke furniture all over the UK and Europe. "Everything is lovingly designed and hand crafted in our workshop in Bristol and within reason, we can make a beautiful piece of furniture in any colour, any size and any shape."

www.mattantrobus.co.uk
07850 664431

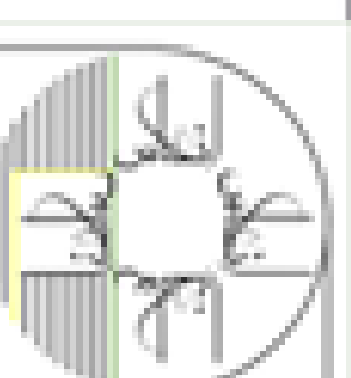
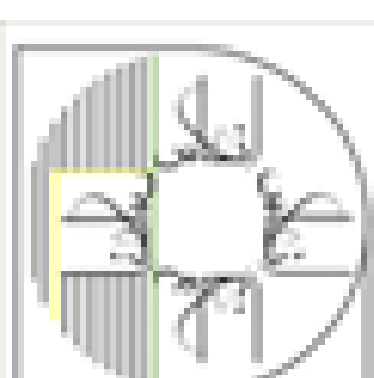

matt antrobus design

beautiful bespoke birch ply

kitchens & furniture
handmade in bristol
www.mattantrobus.co.uk
07850 664431



آموزشگاه انعکاس منبع جدیدترین اطلاعات، مقالات و دوره‌های آموزشی دکوراسیون داخلی

 Enekas.Academy

 Enekas.Academy

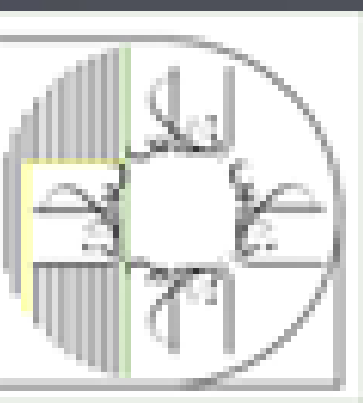
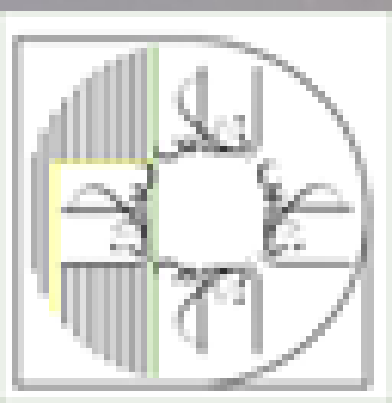



Skelton Lake is a new concept for motorway services. There was a desire for a unique sustainable design which would blend seamlessly into the landscape. Finalist in the Structural Timber Awards, the brief for the central building was exposed long span glulam beams with an undulating sedum roof.

LET'S BUILD BACK BETTER

As global leaders grapple with issues surrounding climate change, the world is gradually coming together to develop strategies to help alleviate the impact of global warming. Here, Andy Goodwin, Managing Director of B&K Structures, shares how we can effectively lock up carbon and maximise the benefits of engineered timber technology in the construction industry.

While the climate crisis can feel like a huge, abstract issue to successfully resolve, we all have a responsibility to contribute to a better, more sustainable environment. Until recently, the benefits of carbon sequestration were not widely discussed. But with growing concern around environmental health, this term is now more widely understood.

Responsibly sourced timber has the capability to vastly reduce our dependency on concrete, decreasing global carbon emissions by 4-8%. Engineered timber builds boast environmental benefits both in terms of raw materials and the numerous advantages associated with offsite construction. In fact, using timber as a core structural component for developments across all sectors is already capturing over one million tonnes of CO₂ through carbon sequestration every year.

Carbon sequestration describes the long-term storage of carbon dioxide (CO₂) to mitigate global warming and avoid dangerous climate change. The natural process of carbon sequestration which occurs in trees enable each cubic metre of timber to store circa 900 kg of CO₂ and hold captive during its entire lifetime, even when it has been processed for use in construction.

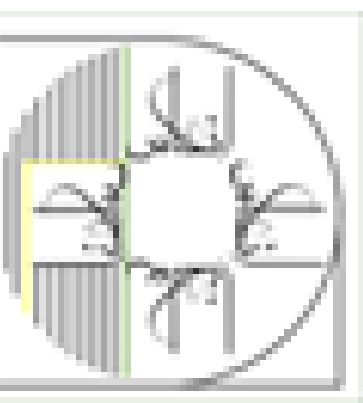



The Pavilion, Hardman Square Manchester was developed from an overriding ambition to fashion a contemporary building almost entirely from timber harnessing prefabrication efficiencies and supply chain control. This impressive structure comprises a primary glulam frame with rib deck panels formed from cross laminated timber slabs with glulam ribs creating the floor and roof.

“

Responsibly sourced timber has the capability to vastly reduce our dependency on concrete, decreasing global carbon emissions by 4-8%.

Solid wood products, such as cross laminated timber (CLT) are natural and far less energy-intensive to produce and apply than alternative structural materials. Not only is it renewable, but the production process also creates minimal waste and all offcuts are recycled. For every cubic metre of CLT manufactured, 676 kg of CO₂ will still be stored.

The overall carbon footprint for a CLT building is lowered by up to 75%. A typical medium rise engineered timber development has the ability to lock up 19 tonnes of CO₂. It is estimated that a single five-storey CLT building is able to cut emissions by levels equivalent to removing as many as 600 cars from the road for a year.

We are not engineered timber purists. Our business model focuses on hybrid construction solutions. However, cross laminated timber is by far the most exciting revolutionary building material that will be significant in our future development plans.

The innovative use of sustainable materials, such as cross laminated timber can help to deliver high-quality, high-density buildings without compromising the environment. I firmly believe it is important to raise awareness of how carbon sequestration and structural timber technology can contribute to reducing carbon emissions.

The UK has a magnificent heritage of timber architecture dating back to the thirteenth century. We are now building on this legacy using ground-breaking engineered timber systems to create a more sustainable future for generations to come.

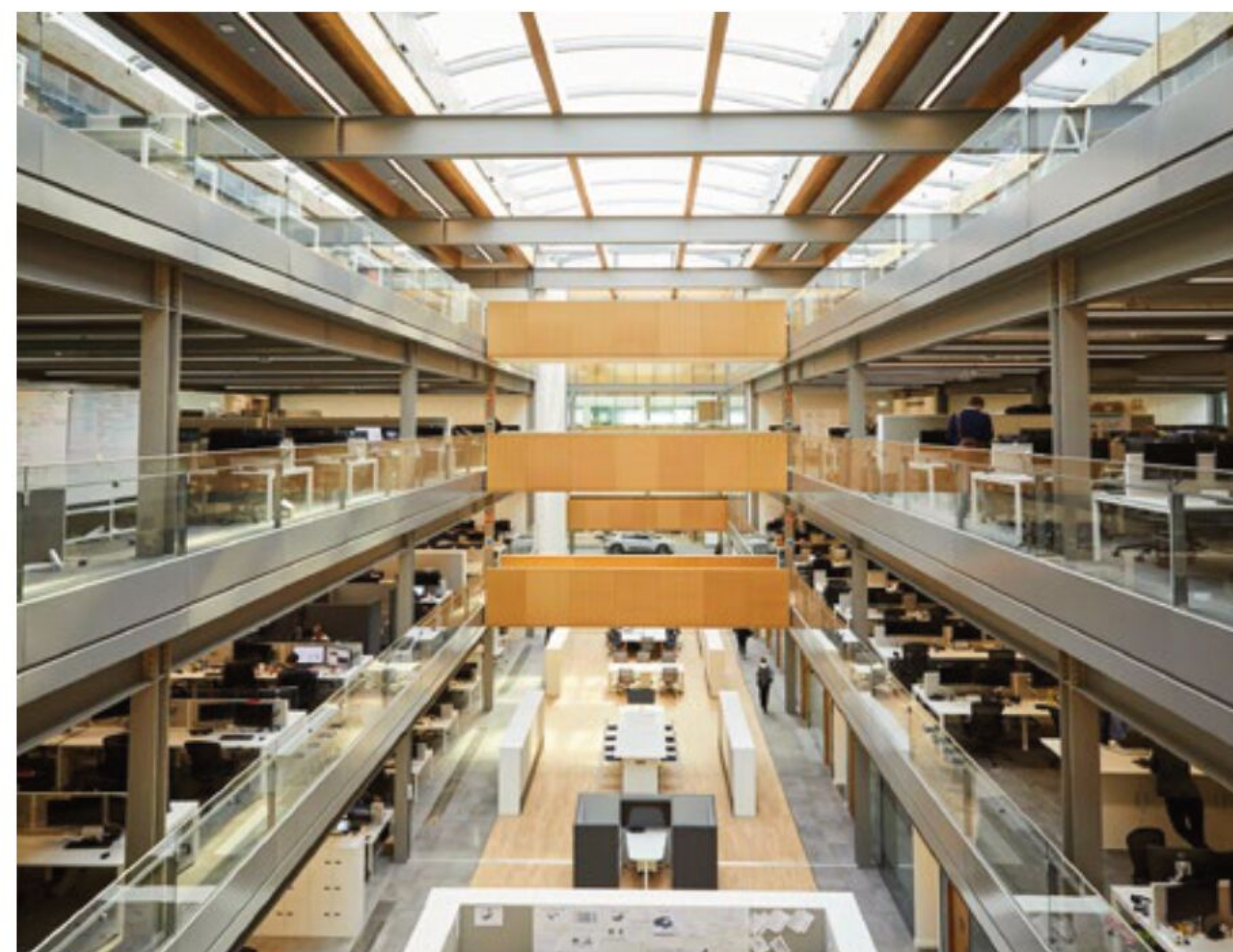

Jaguar Land Rover's Advanced Product Creation Centre reflects the design quality and company values associated with one of Britain's most iconic automotive businesses. Winner of the 2020 Offsite Award for best commercial project, the company's sustainability and wellbeing strategy shaped the building philosophy.



The Arts Centre at Sherborne Girls School provides an inspirational recital space for the whole school to congregate, complete with dedicated performance and arts facilities.

ABOUT B&K STRUCTURES

Through careful design detailing and value engineering, B&K Structures is able to offer the best possible offsite manufactured construction solutions, ensuring a smooth integration for follow-on trades – delivering award-winning, environmentally and sustainable projects on time and to budget.

B&K Structures has worked with some of the UK's most renowned clients to develop outstanding buildings with sustainable credentials. For more information on their product portfolio and full range of services go to www.bkstructures.co.uk

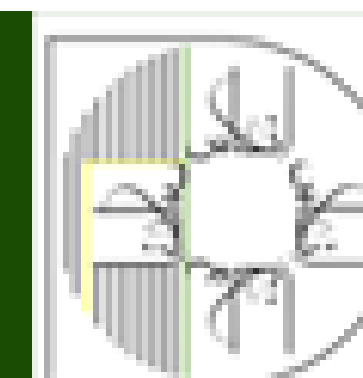

RUBIO MONOCOAT OIL

Over the last decade, Rubio Monocoat has become the market leaders in all-natural, 0% VOC wood oil, now available in more than 82 countries. With hundreds of colour options for interior and exterior wood surfaces, a comprehensive product portfolio, we pride ourselves in being the ultimate wood finishing brand in the market!

For interior wood surfaces we have 60 standard colour options in our 'Oil Plus 2C' range, from a dark 'Charcoal' to a light 'Cotton White' and even a 'Pomegranate Pink'.

For an optional pre-treatment we offer our 'Pre-Color Easy' water based stain for an even more creative undertone that can be used in combination with our 'Oil Plus 2C'.

Our 'RMC Pre-Aging', creates an aged look and feel before sealing it with our oils, which is available in 10 standard colours, from a light "Authentic" brown to a dark "Fumed Intense". 'RMC Pre-Aging' is specifically popular for those who bought new wood but prefer an older look to match existing wood surfaces as well as for a creative undertone.

For a complete natural look and feel, our latest product in our range, 'Invisible Protector' was specifically developed to give an un-treated and raw look to wood as the name suggest.

For high traffic areas such as an entrance walk ways and kitchen countertops, we also provide an 'Oil Varnish' which has a matte finish and it can be applied on top of our 'Oil Plus 2C' for that extra protection.

For exteriors, our goal is to protect the wood from UV discolouring and fungi, which is why we have developed our 'Hybrid Wood Protector'. Available in 20 standard colours, it can be applied on all exterior wood surfaces such as cladding, furniture, decking, pergolas, as well as for interior wood. For a more intense colour, one can opt for our 'HWP Sunprimer' as a base coat, which gives the wood even better protection from the sun's UV rays through its colour pigments, and enhances the 'Hybrid Wood Protector' colour to be applied.

For the ultimate water resistant finish for vertical wood such as cladding, railing, trusses etc, our 'Rubio WoodCream' is recommended as it propels water from its creamy structure. There are 7 standard colours available as well as a transparent version.

If you are looking for a product that can be used on your vertical wood surfaces as well as on stone and metal surfaces, our 'Rubio HydroCream' is recommended. It also has water repellent properties and is available in 24 exterior colours in total and comes in 2 collections: The 'Traditional Collection' which includes colours such as Dirty Grey, Mocha Cream, Salted Caramel and the 'Scandinavian Collection' that includes colours: Oslo Ochre, Swedish Red and Fjord Blue, to name a few. These 24 exterior colours can also be mixed together, so you can create a personal exterior style for your house or project.



To provide the very best care for all your wooden surfaces, Rubio Monocoat has a complete aftercare product range that includes Interior & Exterior Soap, Refreshing Oils, Stain Removers as well as oil application pads and buffing pads.

For more information visit our website at www.rubiomonocoat.co.uk or give us a call on: +44 (0)1827 59041

If you would like to purchase our products online, visit www.rubiomonocoatonline.co.uk

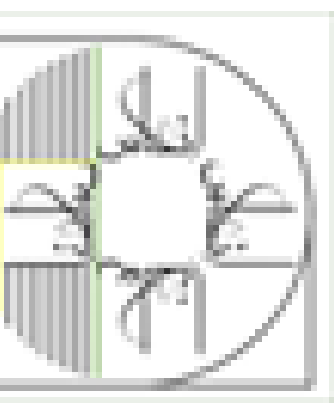



Rubio Monocoat Oil Plus 2C

Colours and protects your wood in ONE coat!

- Pre-Aging effects
- Easy to maintain / repair
- Unlimited colour options
- Food and toy safe
- Eurofins Gold Label
- 100% Eco-friendly

7A Vanguard Way, Battlefield Enterprise Park,
Shrewsbury, SY1 3TG, +44 (0) 1827 59 041,
www.rubiomonocoat.co.uk

Rubio® **MONOCOAT**
YOUR PARTNER IN WOOD PROTECTION

آموزشگاه انعکاس منبع جدیدترین اطلاعات، مقالات و دوره‌های آموزشی دکوراسیون داخلی

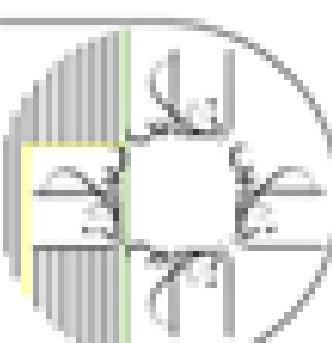

Colourful duplex coatings provide longevity for steel protection.

Guaranteed for up to 40 years (*subject to T&Cs).

Superior duplex coatings for steel

Improve the appearance and prolong the life of steel with superior duplex coatings – a synergy of hot dip galvanizing and powder coating – from Joseph Ash Medway.

Suitable for all types of architectural steel fabrication, including gates, railings, staircases, lighting, and flooring.

Protect and perfect your steel projects with our one-stop-shop service.

Contact us today for a no obligation quote!

40
GUARANTEED*

Joseph Ash Medway

Castle Road, Eurolink Industrial Centre, Sittingbourne, Kent, ME10 3RN

+44 (0)1795 479489

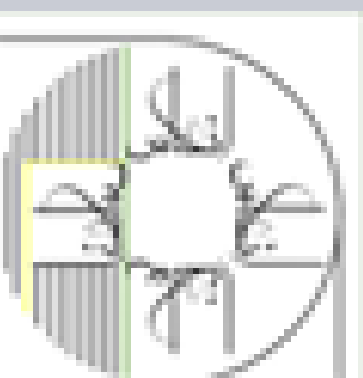
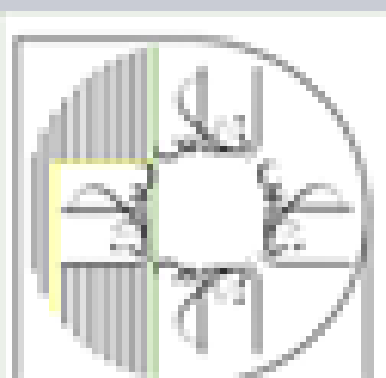



HR PROF THE ECO-FRIENDLY FIRE RETARDANT

- Water based - does not leach
- Allows wood to breathe naturally
- Internal/External application
- Colourless - Odourless
- EN 13501 - 1
- Non Toxic - No Solvents
- BS 476 part 6 & BS 476 part 7
- Euro-class B-s1-d0 and C-s1-d0
- BM TRADA ISO 9001 Certificate
- Meets the **highest** EU standards



Classification Reports and Certificates for HR Prof: Pine, Spruce, Scotch/Siberian Larch, Western Red Cedar, Oak, Plywood & More

ALSO FOR WOOD PROTECTION: Fire Retardant UK One Coat Interior

A clear, colourless treatment for Euroclass B s2 d0 and Class O in a one coat application on porous wood, porous-faced plywood and porous wood based boards.

Fire Retardant UK Top Coat Sealer Interior Option

For protection against dirt, UV, and splinter resistant surface - a wipe-able sealer for application over Interior One Coat. In Clear or Wood-Stain - Matt or Satin finish



t 0800 7833 228

e sales@fireretardantuk.com
w www.fireretardantuk.com

DOING THINGS DIFFERENTLY

Earthborn is delighted to introduce The Earth Collection, a palette of five harmonious new paint shades inspired by the natural world, themed around the earth, land, sand, sea and clouds. The Classic Earthborn colour card will remain unchanged for now; instead a simple bookmark is available displaying real painted swatches of the five new colours.



The new colours, and the full range of 72 shades on the Classic shade card, are available to buy online now, or from Earthborn's network of stockists.

Crocky Road: Inspired by the earth, its faintest green undertone lends Crocky Road an easy, earthy quality.

Up Up Away: Inspired by the clouds, Up Up Away is a cool, calm and collected off-white shade.

Grassy: Inspired by the land, this elegant grey-green is reminiscent of misty, mountainous landscapes.

Skipper: Inspired by the sea, this warm denim shade has a casual charm.

Sandy Castle: Inspired by the sand, and the feeling of sunlight on sand dunes to create our own take on cream.

With Earthborn you get no acrylics or oils, but you get high quality and high performance and a full list of ingredients to help you make a more informed choice.

<https://earthbornpaints.co.uk/>



SiOO:X
WOOD PROTECTION

Working with nature

Sioo Wood Protection AB are leaders in wood protection using silicate technology.

Specified by architects across Europe, our patented SiOO:X product gives long life and a beautiful natural surface with even colouration. It is friendly to people and the environment. An example of a SiOO:X project is this house in Devon where the Siberian Larch cladding was factory treated by Russwood Timber with SiOO:X Mid Grey pigment.

Sioo Wood Protection AB
www.sioox.org.uk

SWEDISH PATENTED SILICON TECHNOLOGY



Photography by Alex Campbell.

ENVIRONMENTAL WOOD TREATMENTS GROW IN POPULARITY

People today want environmentally safer products matched with reliability of quality. With the recent surge in wood cladding and timber exposed properties, paints and wood coatings are now a vital part in the choice of design and long term protection.

The Witham Group who have manufactured and supplied paints for 100 years are now at the edge of this growing market place offering two environmentally sensitive product ranges that are catching the eye of consumers and professionals alike.

Osmo is renowned for its award winning wood treatments that combine product performance and natural, environmentally friendly ingredients. The products are based on rapidly renewable, natural vegetable oils that penetrate deeply into the wood, keeping it elastic and healthy, whilst preventing it from drying and becoming brittle.

Osmo is now over 100 years old and originated in Germany. Its products are popular wood oil finishes used to protect interior and exterior wood yet have outstanding environmental credentials. Osmo uses only carefully

harvested natural oils (sunflower, soya, linseed and thistle oils) and hard waxes (carnauba and candelilla waxes) for its finishes. The products are food safe and simple to apply with no sanding or primer required. Thin coats are sufficient with huge coverage of up to 25sqm per litre.

Woco Barn Paint (Witham's own range) has a low VOC, water-based structure, ideal for creating colour on cladding, outside timber, garden furniture, outbuildings, sheds and more.

In a beautiful range of 13 coastal themed colours, the range is ideal for transforming dull fencing, gates, and properties whilst offering a tough durable microporous protective coating with excellent colour retention. The barn paint range has excellent adhesion to a wide variety of surfaces and so can be used for both commercial and residential purposes.

Celebrating 100 years of business, Witham Group are proud to be able to offer these product ranges at the forefront of wood care and environmental technology. For more information, visit www.withamgroup.co.uk or contact the trade paint depots at Soham and Lowestoft.

OUTSTANDING NATURAL FINISHES FOR INTERIOR & EXTERIOR WOOD



Recommended by Professionals & Architects

Osmo is renowned for its outstanding wood treatments that combine product performance and natural, environmentally friendly ingredients. The products are based on rapidly renewable, natural vegetable oils that penetrate deeply into the wood, keeping it elastic and healthy, whilst preventing it from drying and becoming brittle.

We offer a wide range of Osmo wood oil finishes to protect both interior and exterior wood with stain, colour or natural tones. Ideal for flooring, panelling, furniture, kitchen worktops, window frames, sheds, decking and garden furniture.



CONTACT US FOR MORE INFORMATION ON ALL OUR PAINTS & COATINGS

LINCOLN | SOHAM | LOWESTOFT

آموزشگاه انعکاس منبع جدیدترین اطلاعات، مقالات و دوره‌های آموزشی دکوراسیون داخلی

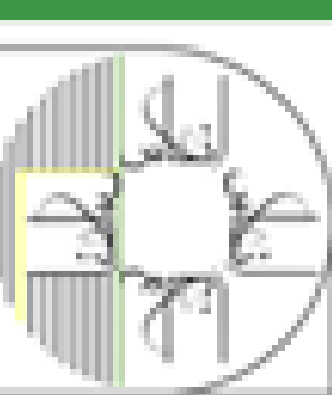
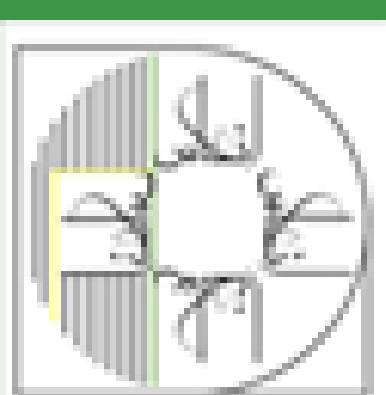



By Appointment to
Her Majesty the Queen
Lubricant Blenders & Paint Suppliers
Witham Oil & Paint Ltd, Lincoln

witham
GROUP

WOCO BARN PAINT RANGE

A STROKE OF GENIUS



GULL GREY



STAITHE GREY



BLAKENEY GREY



CLEY WHITE



BURNHAM GREEN



SCOLT STONE



THORNHAM GREEN



SAMPHIRE GREEN



SEA FOAM



HARBOUR BLUE



ALDEBURGH BLUE



SOUTHWOLD BLUSH

AVAILABLE IN A CHOICE OF 13 COASTAL THEMED COLOURS

Blending Quality. Value & Service since 1921

آموزشگاه انعکاس منبع جدیدترین اطلاعات، مقالات و دوره‌های آموزشی دکوراسیون داخلی

Enekas.Academy

Enekas.Academy

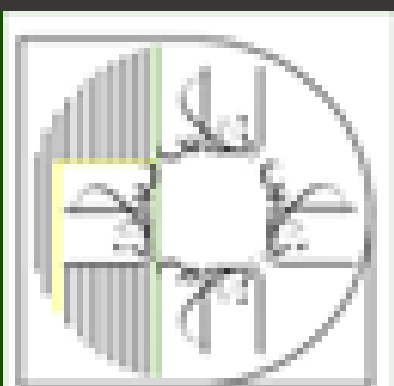
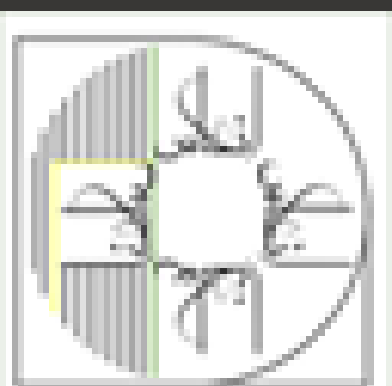



ADDING LONGEVITY TO THE SUSTAINABILITY DEBATE

STEVE THOMPSON, MANAGING DIRECTOR FOR SPECIALIST STEEL FRAMING MANUFACTURER EOS, ADDS LONGEVITY AND BUILDING PERFORMANCE TO THE SAFETY VERSUS SUSTAINABILITY DEBATE

It is a fundamental of good design that buildings and structures should be safe and that measures to enhance their environmental performance should not compromise this essential requirement.

Buildings should not only be inherently safe but should also be constructed to last a long time and therefore be inherently sustainable. Buildings are responsible for almost half of the UK's carbon emissions and around a third of its landfill waste. This means that the UK's sustainable development targets cannot be met without a major change to the way in which buildings are designed, constructed and operated.

National targets for carbon emission reductions and the drive for buildings that are 'low carbon' in operation present a huge challenge to the construction industry – a challenge which the steel construction sector is playing a major part in overcoming.

Steel can be recycled or reused endlessly without detriment to its properties. This unique characteristic gives steel a high value at all stages of its life cycle. The recovery infrastructure for steel recycling is highly developed and extremely efficient and has been in place for decades. Current recovery rates from demolition sites in the UK are 99% for structural steelwork and 96% for all steel construction products – figures that far exceed those for any other construction material.

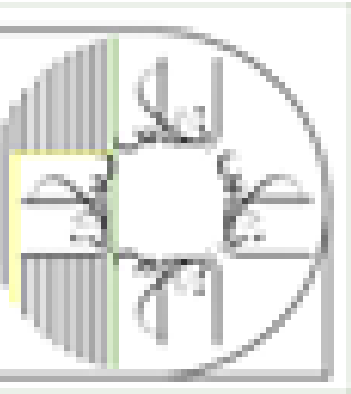

Steel's material properties make it the ultimate sustainable construction material both in terms of its longevity, material properties and enhancing the safety credentials of steel-framed buildings.

Its superior strength-to-weight ratio means a little steel goes a long way, giving architects complete flexibility to innovate and create new and exciting buildings. Low and zero carbon buildings and buildings with high BREEAM ratings are readily achievable using steel construction.

An excellent example of this is a project EOS were involved in to create a prestigious £25million flagship Travelodge hotel in London that was developed as a declaration of renewed confidence in the brand following substantial investment. The aim was to deliver a fully clad offsite manufactured panelised steel frame system, complete with the sub frame of SFS infill panels, pre-fixed to a lightweight innovative stone cladding solution which not only looks outstanding but also achieves a highly energy efficient, non-combustible building envelope. Once delivered, the fully-formed panels were craned in and fixed back to the substrate.

The impressive eight storey, 395-room property is built to BREEAM excellent standards and delivered through innovative engineering combined with technically advanced offsite manufacturing. The greater efficiency and quality associated with sustainability is also helping to make this Travelodge more commercially successful. There is growing evidence that BREEAM Excellent buildings provide increased rates of return for hotel operators. BIM Level 2 technology combined with design for manufacture and assembly protocols reduced errors onsite and snagging – as well as enhancing the energy performance throughout the lifecycle of the building.

When the cost of operating a building for 30 years can be four times greater than that of designing and building it, it is no surprise that those who own and maintain buildings are keen to find in-use savings. Now we have more sophisticated research available, the equation of 'build them high build them cheap' – simply does not stack up from an owner operator's perspective. And this is

why steel framing systems are favoured by the build-to-rent, education, healthcare and other public sector buildings.

The UK leads the world in steel construction both commercially, technically and in terms of quality. The industry has made dramatic improvements in technology, productivity and efficiency. According to research carried out by independent consultants Construction Markets – steel continues to be overwhelmingly the structural framing material of choice with their survey showing that steel now has a 72.5% share of the multi-storey office market and a 60.9% share in the 'other multi-storey buildings' which includes retail, education, leisure and healthcare sectors.

Quality, safety and sustainability are at the very core of our organisation, it is therefore with great pride that I share that EOS has just successfully completed three quality badge audits with 100% success and zero non-conformances. This is an outstanding achievement and testament to the work that went in to ensuring all procedures, records and management systems were in first-class order providing the auditors with all the necessary information to award EOS total compliance with zero non-conformances. We successfully passed the five-day re-certification audit against ISO 9001:2015 quality management systems, ISO14001:2015 environmental management systems and ISO45001:2018 health and safety management with no non-conformance issues or even any opportunities for improvement or areas of concern. I would like to take this opportunity to publicly thank my team for their hard work and dedication to achieving the ultimate standard.

Partnerships are central to our business. We have a wealth of experience and our specialist teams strive to support our clients throughout the design and construction phase. EOS has the capability and capacity to meet the exacting demands of the construction industry and guarantee a very competitive price structure with no hidden costs for deflection heads or transport and we can provide a lump sum total cost which will not alter, providing the specification remains unchanged.

To view video case studies including the Travelodge Hotel and client testimonials visit:

www.eosframing.co.uk/information-centre/video-vault



Southwark Town Hall – mixed-use development

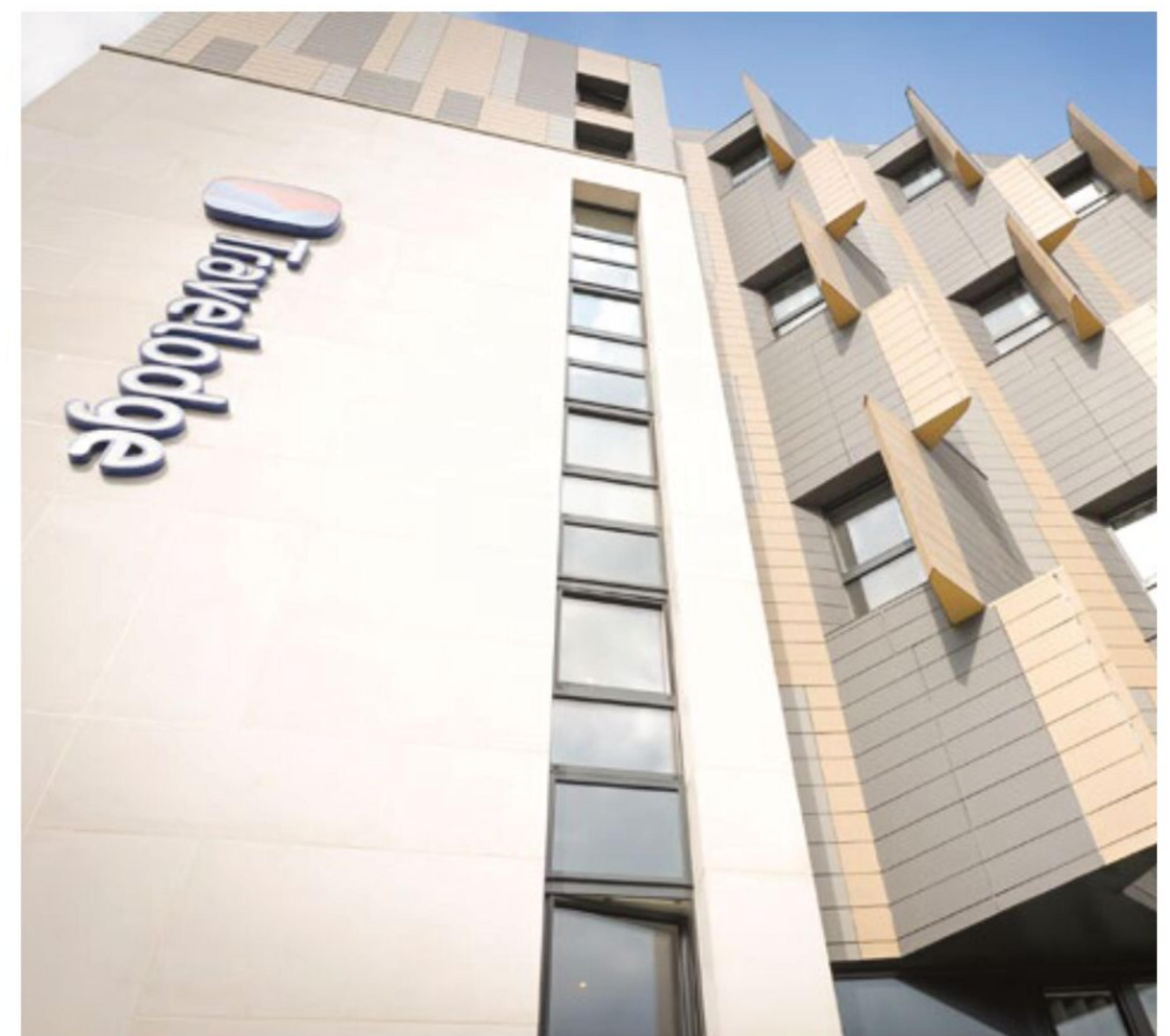

Travelodge, Middlesex Street, London – hotel development



CHRIST & GANTENBEIN COMPLETES THE MULTIFUNCTIONAL LINDT HOME OF CHOCOLATE

MUCH MORE THAN A MUSEUM, THIS VERSATILE
PROJECT REDEFINES WHAT CIVIC BUILDINGS CAN BE

The headquarters of Lindt & Sprüngli, the Swiss chocolatier, founded in 1845, are located near Lake Zurich on the outskirts of Switzerland's most populous city. The firm's long and successful history of producing quality chocolate manifests creations from Lindt & Sprüngli as the epitome of quality chocolate. Its products are available in more than 120 countries worldwide. They are sold by 28 subsidiaries in more than 500 of its own stores. Lindt & Sprüngli's HQ features a factory, warehouses, an office building, and the new gateway to the campus, the Lindt Home of Chocolate, which is financed and operated by the Lindt Chocolate Competence Foundation. This new flagship building is a striking, contemporary counterweight to the eclectic assemblage of buildings.

Set to become one of Switzerland's most visited buildings, this multifunctional experiential space combines a user-focused, mixed-use program in an exceptional new type of civic architecture. Elevating the visibility of the Swiss Chocolate industry to new heights, it is built to seduce visitors with the many charms of chocolate. It features an interactive, immersive exhibition about chocolate, a research and development facility for future chocolate recipes, a production plant, a chocolate shop, a cafe, and offices – all connected by spiraling staircases and cascading walkways crisscrossing a vast atrium. In its center, a dramatic, nine-meter high, golden chocolate fountain was developed by Atelier Brückner, also authors of the exhibition.

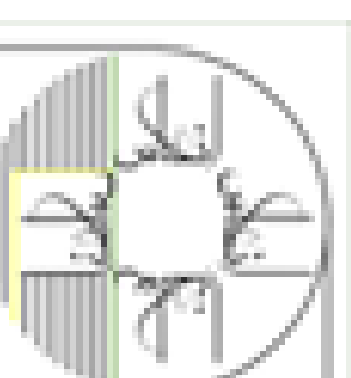
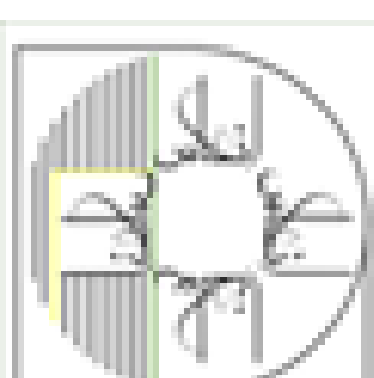

“

Elevating the visibility of the Swiss Chocolate industry to new heights, it is built to seduce visitors with the many charms of chocolate.

Designed by Christ & Gantenbein, the Home of Chocolate parallels Lindt & Sprüngli's factory site's logic, history, and urban structure: A classically composed, industrial box, in dialogue with the surrounding factory buildings. The facade, consisting primarily of red brick, references its neighbors in an abstract reinterpretation based on a readymade industrial product that is manually grafted into a specific construction element. The south-eastern corner is cut out and interrupts the otherwise simple volume. Clad with white, glazed brick adorned with golden letters, this quadrant opens a public square right at the Lindt Home of Chocolate's entrance.

A vast atrium, 64 meters long, 15 meters high, and 13m wide, reveals both a dramatic void and the architectural order's elementary presence. A series of round load-bearing pillars and walls create a robust structure around which all activities are organized. The columns reveal a building full of movement; stairs, elevators, walkways, and bridges produce spatial and experiential connectivity and communication, which is at the core of the Lindt Home of Chocolate, radically contrasting its almost calm exterior.

At first glance, what appears simple is actually an intelligently engineered building of multifaceted complexity; a solid architectural form built to last, yet at the same time, built to withstand fluctuations through flexibility; where resilience and robustness collaborate towards a multiplicity of potentially shifting applications. The Lindt Home of Chocolate's structural system is itself a hybrid, where aesthetic, functionality, and construction come together in a column-free volume with a load-bearing outer shell.

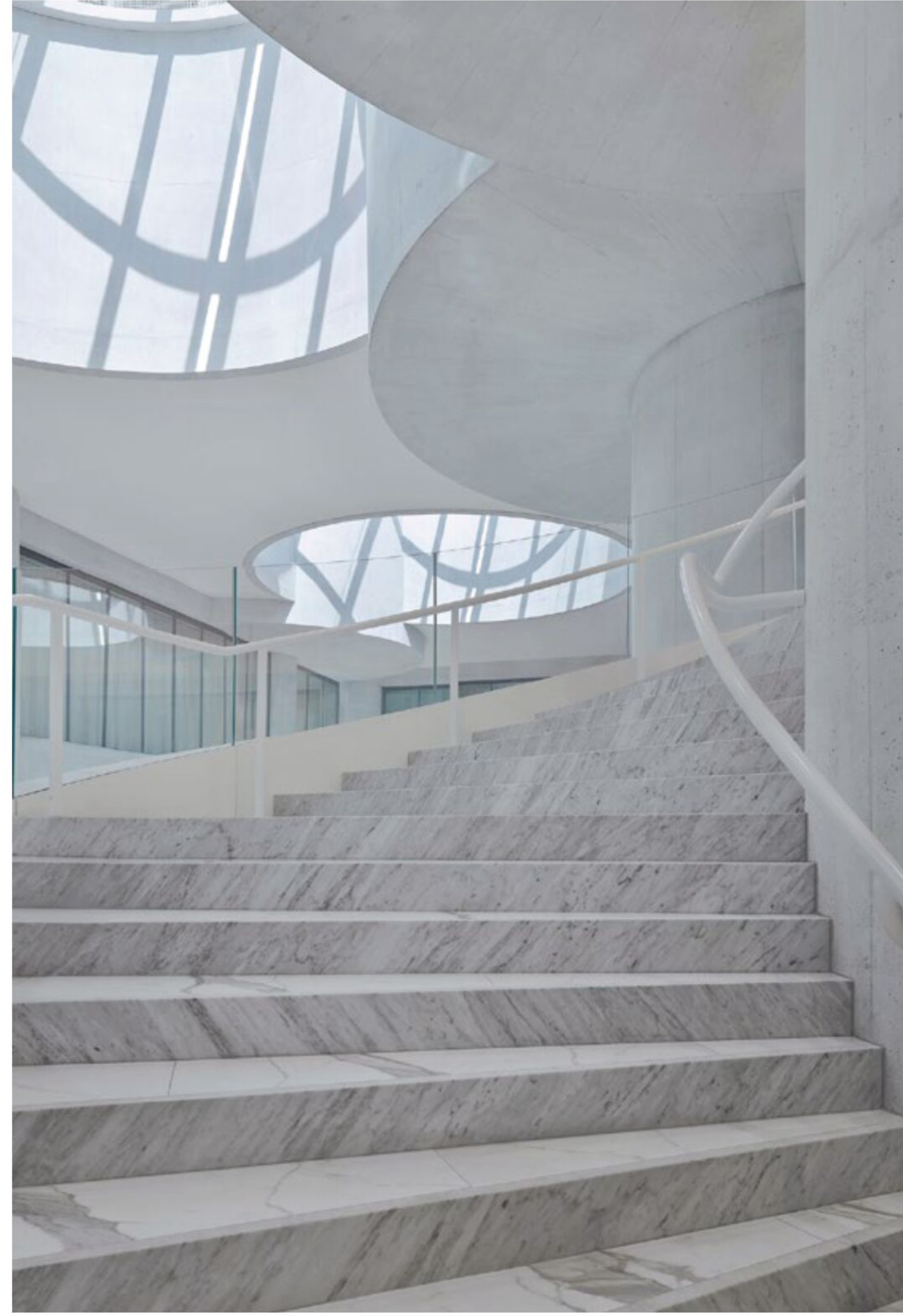

Lindt Home of Chocolate - Staircase
Photo: ©Walter Mair



Lindt Home of Chocolate - Front View
Photo: ©Walter Mair



Lindt Home of Chocolate - Atrium
Photo: ©Walter Mair

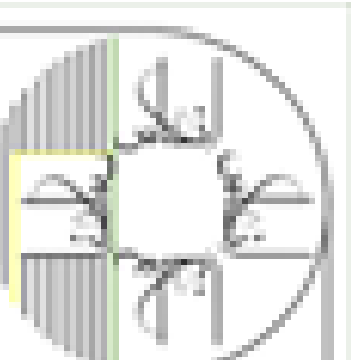

CHRIST & GANTENBEIN

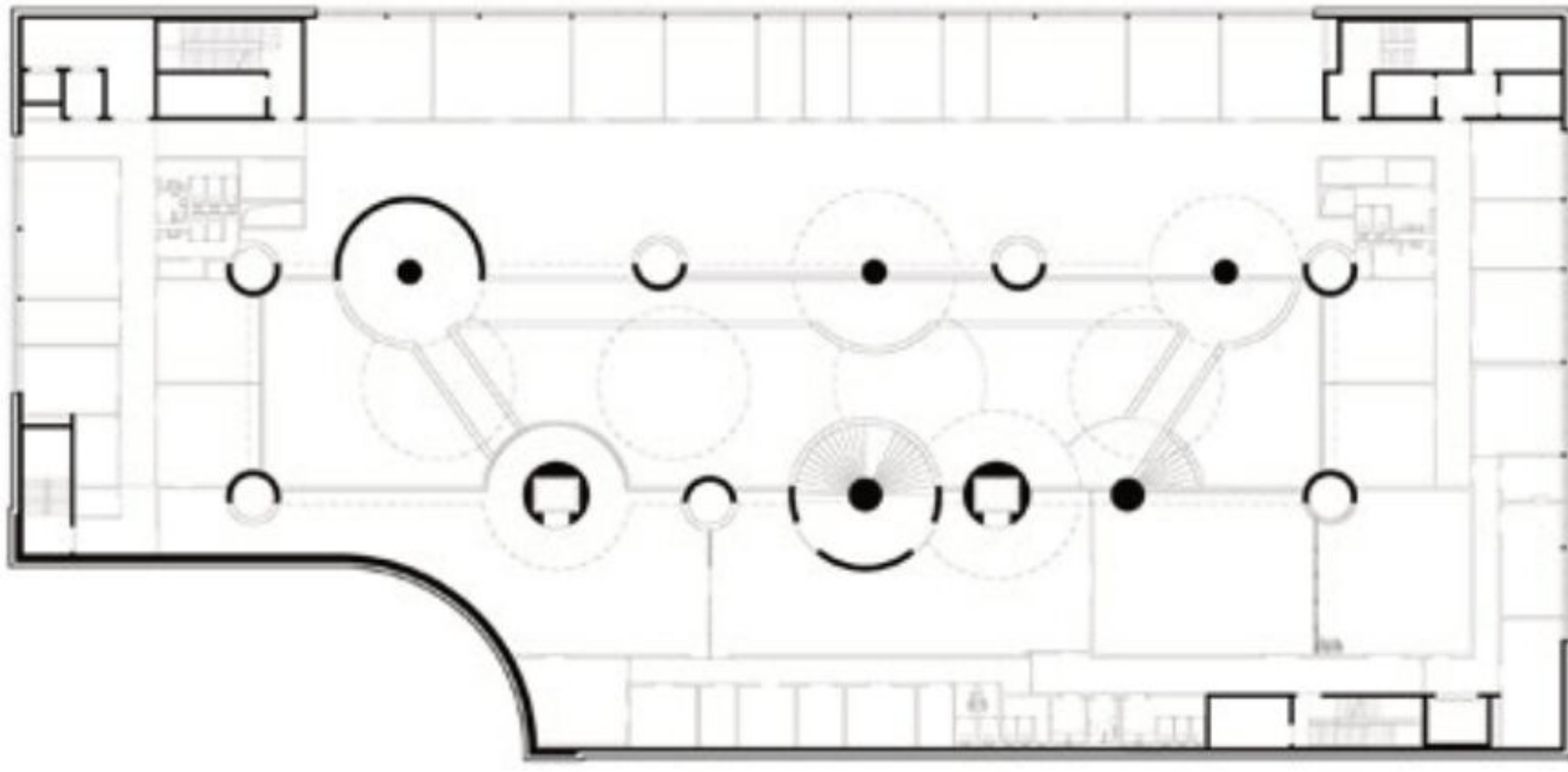

Lindt Home of Chocolate - Second floor Drawing: ©Christ & Gantenbein

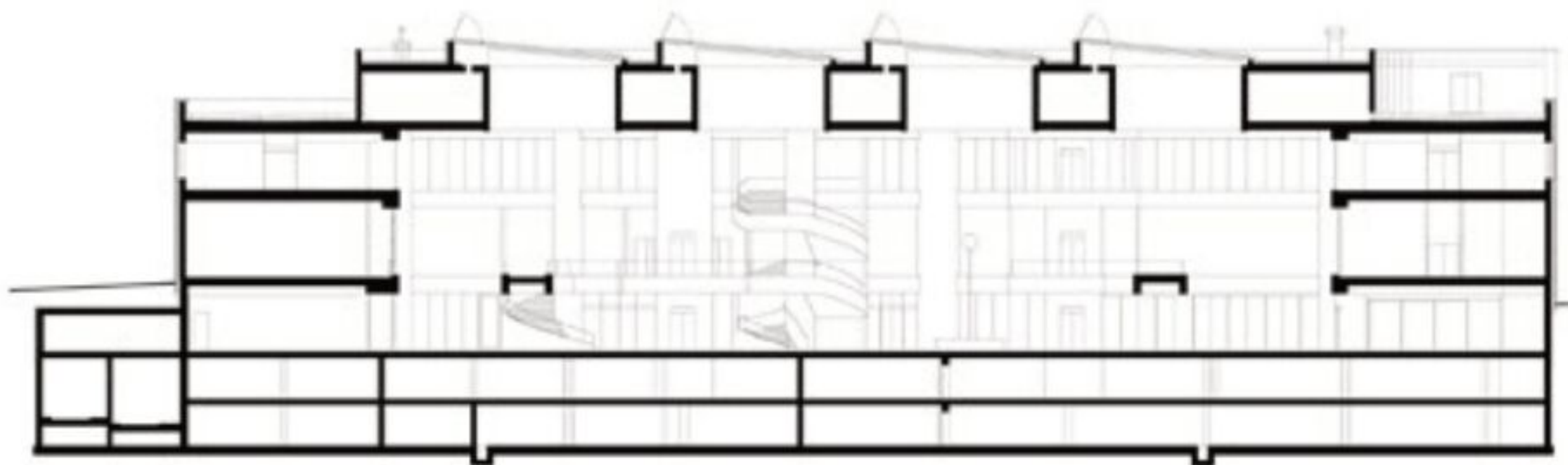

Lindt Home of Chocolate - Section Drawing: ©Christ & Gantenbein

Emanuel Christ says ...“Almost reaching an ancient Roman scale, we've created an exaggeration of industrial production with a certain tension; a tension that gives a strong presence to the architecturally distinct elements that define the interior, bridging the substantial gap between a commercial ambiance and classical grandeur. To celebrate the experience of chocolate in many ways, we've scripted the Lindt Home of Chocolate's interior as a space that orchestrates the movement of people.”

Jürg Conzett, structural engineer for the Lindt Home of Chocolate: „The supporting structure in the interior essentially consists of an in-situ concrete skeleton. In the area of the atrium, the load-bearing parts become multifunctional elements. Thus, mushroom pillars mutate into cantilevered balconies, and hollow

columns contain elevators as well as zones for pipes to ascend. Generously dimensioned spiral staircases also circle around these vertical support elements. The unusually large dimensions of the supporting structure create a unique scale and contribute to the extraordinary spatial effect of this building.”

The Lindt Home of Chocolate, Christ & Gantenbein's second completed cultural project in Zurich, besides the Swiss National Museum and its extension, is a highly technical and complex hybrid. Combining industrial production, showroom, museum, shopping, and cutting-edge research & development, among others in collaboration with the Swiss Federal Institute of Technology, it's ultimately a space where contemplation, entertainment, research, and interaction come together in a new spatial experience.

PROJECT FACTS

LOCATION: Kilchberg, Switzerland

CLIENT: Lindt Chocolate Competence Foundation

YEAR:2014 - 2020

PROGRAM: Culture, Laboratory, Museum, Office, Retail

SIZE: GFA 21'540 m²Length: 93 m. Width: 45 m. Height: 21 m

TEAM

FOUNDING PARTNERS: Emanuel Christ, Christoph Gantenbein

PARTNER: Mona Farag

PROJECT LEADERS: Anna Flückiger, Astrid Kühn, Tabea Lachenmann

CHRIST & GANTENBEIN ARCHITECTS: Javier Bressel, Ana Sofia Costa Guerra, Eileen Davis, Szabolcs Egyed, Florian Kaiser, Kyrill Keller, Daan Koch, Andrew Mackintosh, Stephanie Müller, Catia Polido, Robert Schiemann, Anne Katharina Schulze, Guido Tesio, Leandro Villalba, Jean Wagner, Leonie Welling, Christina Wendler

www.christgantenbein.com

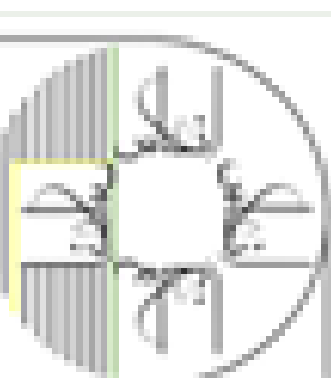

Photo: ©Raphael-Alu

آموزشگاه انعکاس منبع جدیدترین اطلاعات، مقالات و دوره‌های آموزشی دکوراسیون داخلی

 Enekas.Academy

 Enekas.Academy





STANZA
ARCHITECTURAL HARDWARE

UTILITY BY DESIGN

Our STANZA range is designed to be both elegant and modern with the affordability to suit both consumer and contractor.

A range of designer zinc levers available on rose and backplate, chrome plated to achieve long performance and great aesthetic appeal.

T : +44 (0) 1228 672 900
E : sales@zoo-hardware.co.uk
W : www.zoohardware.co.uk

For further information on this range visit our website or call one of our friendly sales team.

STANZA is part of Zoo Hardware Ltd. 



Mirror Door Systems Limited
reflecting your lifestyle

Mirror Door Systems Ltd

Made to measure and Bulk quantities of Sliding Door Systems to the trade and public nationwide.

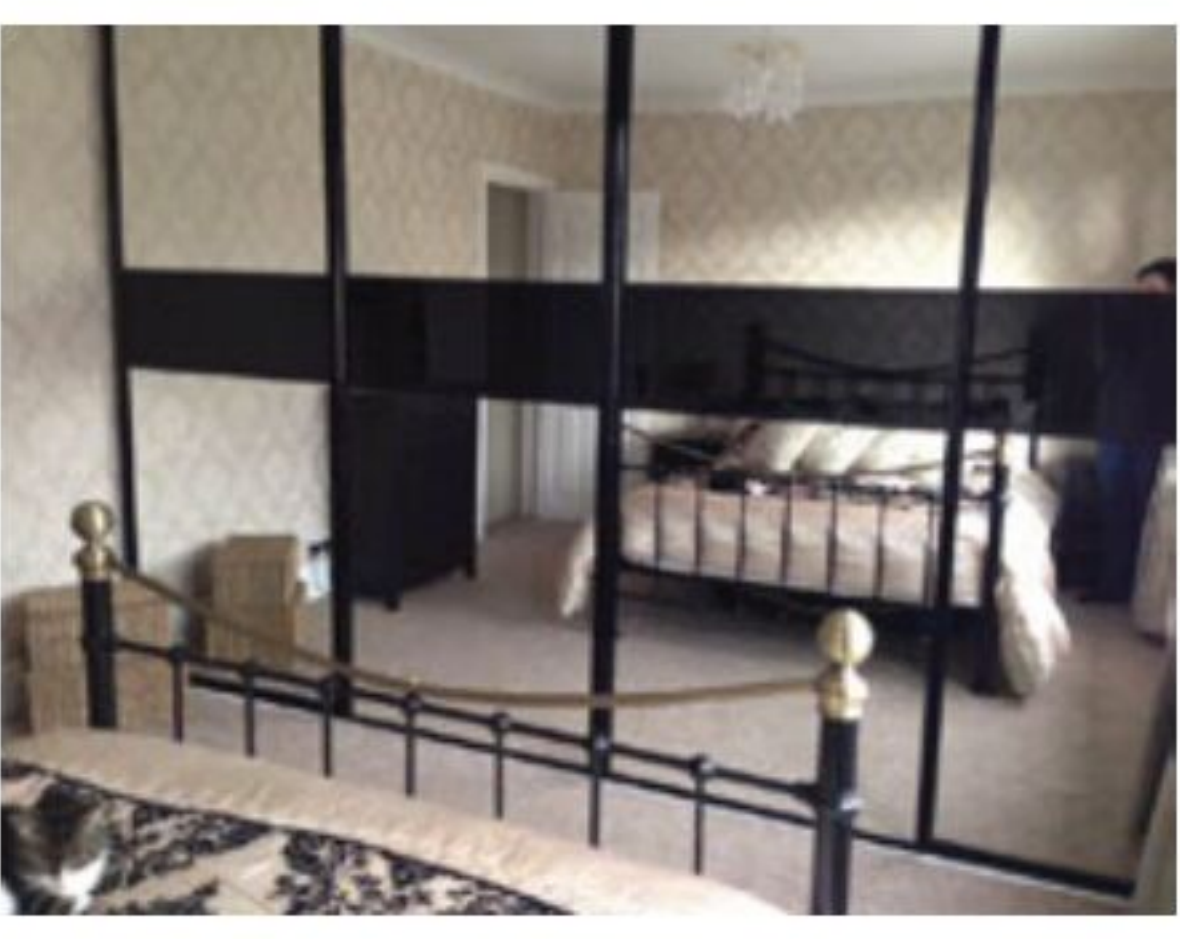

All systems incorporate anti-jump safety features and have been designed to accept the choice of safety backed mirror, opaque glass (BS6206 Class B) and/or panels.



The full range of now extends to 5 superb systems with nearly 40 different colours including woodgrains to choose from:

Solitaire & Topaz	Steel systems with painted & vinyl finishes
Diamond	Aluminium (dual) systems anodised and a powder coated finish mid-rails to match
Pearl	Aluminium system with woodgrain finishes plus mid-rails to match and option soft door closers
Cerroni	A unique small aluminium profile with track system and door closers
Tuscany	An aluminium system, with classical and elegantly designed profiles and selected modern colours and features with door closers

Tel: +44 (0) 1268 573357
Web: www.mirrordoor.co.uk
Email: salesmds@mirrordoor.co.uk

Planned to be associated with the Essex Wildlife Trust

COMAR LAUNCH THE ECO LT WINDOW & DOOR SYSTEMS

Comar profiles have thicker walls providing extra strength and durability for the British market, ensuring that Comar performs. Designed specifically for the British Market and offering a truly British engineered solution.

Comar ECO LT sightlines have been minimised whilst not sacrificing product performance. Large sizes come as standard from the same range of profiles.



5P.i ECO LT - ALUMINIUM WINDOW SYSTEM

Comar 5P.i ECO LT Aluminium Casement Window System has both internally and externally glazed options. With the resurgence of slim aluminium high security externally beaded with sloped beads minimises the sight lines and maximises daylight. The square chamfered profiles are a distinctive feature of this system, keeping the square look of a truly aluminium solution.

For Ovolo feature the ECO range seamlessly suites in: No matter the situation Comar 5P.i ECO LT delivers.

7P.i ECO LT - ALUMINIUM DOOR SYSTEM

Comar 7P.i ECO LT Aluminium Door System has both inward and outward opening options in single or double door combinations. There are two thresholds available high weather performance and low-rise for seamless balcony terrace integration. Comar 7P.i ECO LT door has been designed to provide high performance solutions for today's specification demands. Utilising Comar's trademark P.i. (Polyamide Insulation) thermal break technology, it delivers superior thermal performance with an aesthetic edge.

Aesthetics come from its slim 55mm profiles, seamlessly integrating with the Comar 5P.i ECO LT casement window system. Comar 7P.i ECO LT has been tested to BS 6375 which ensures the door performs well against the rigours of the British weather, reducing draughts and providing excellent weather proofing.

Security concerns are alleviated with the Comar 7P.i ECO LT door exceeding the requirements of PAS 24:2016.

For further information about Comar Architectural Aluminium Systems, please visit www.comar-alu.co.uk, call 020 8685 9685 or email projects@parksidegroup.co.uk

TOUCH

IRONMONGERY LTD

www.atouchofbrass.co.uk

210 Fulham Road, Chelsea London SW10 9PJ

THE PERFECT TOUCH

**Touch Ironmongery is one of London's leading Architectural Ironmongers
Established in October 1982**

Originally called "A Touch of Brass", the firm changed their name in 2003 in reaction to slowly advancing market changes in architectural ironmongery which is no longer supplied solely in brass, and to also reflect the broader range of product and finishes that they sell.

In fact today, Touch can supply a wide range of finishes including Brass, Satin Brass, Polished Chrome, Polished Nickel, Satin Nickel, Copper, Bronze – solid and plated, BMA, Antique Brass, Black, Pewter, Ceramic, Leather, Stainless Steel, Satin Stainless Steel, Gun Metal, and the list keeps growing. Whatever finish you require, Touch can help you get the right look.

Touch occupy their recently refurbished showroom at 210 Fulham Road, Chelsea, where they display a vast range of their 5,000 products. With a customer base including Interior Designers, Builders and Individuals who are interested in the quality end of the Ironmongery market, Touch mainly supply to residential premises but hotel and office properties also contribute to their vast clientele.

The company also have a healthy export market to all corners of the world, namely the Middle East, Europe and the Americas. Touch's owner and founder, Bill Benham, has 38 years' experience in the ironmongery trade, as do his colleagues Jim Haselup and Alan Blanchard. Saleem Qureshi is the newest member of our team and has 10 years' experience, meaning their knowledge is unrivalled in this industry.

The range of products supplied by Touch date from circa 1640 French (Louise XIV) and cover all subsequent periods (Georgian, Edwardian & Victorian), art deco and contemporary pieces also make up the product ranges. In addition, Touch showcases the very best of British manufacturing; the best ranges are still produced in the Midlands by craftsmen in factories dating back 200 years or more.

Touch Ironmongery have recently become suppliers for **Designer Doorware (Australia)** who have beautiful products with a cutting edge design Metal, Wood and concrete. We also have the exclusive rights to sell the **Olaria (Barcelona)** range in the UK.

Olaria make all our bespoke products, they have incredible levels of workmanship. Touch also sell European manufactured goods which is considered to be of a very good quality and in recent years they have introduced some of the far eastern made products, albeit in a limited range but cost effective. With trends continuously evolving new innovative products are constantly under development. Touch understand that keeping up with the fashion-shifts is imperative in order to provide every customer with the best solution for their requirements.

Ironmongery can be a difficult and complicated aspect of a building project, as a result Touch aim to take this awkward aspect and make it user friendly and clear to understand by offering an on-site service where they carry out a detailed door by door, window by window, room by room Ironmongery schedule, highlighting all requirements and identifying any items that can be refurbished. Refurbishment is a large part of the business; Touch will undertake complete ironmongery refurbishment projects, and can restore old paint covered door furniture to their former glory, looking as new, at a fraction of the cost to replace.

**For more information about Touch Ironmongery or to arrange a
showroom visit please call 0207 351 2255 or alternatively
visit www.atouchofbrass.co.uk**

آموزشگاه انعکاس منبع جدیدترین اطلاعات، مقالات و دوره‌های آموزشی دکوراسیون داخلی

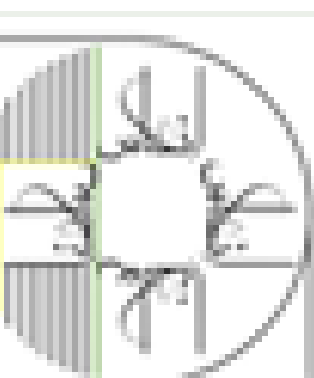



BRITISH & EUROPEAN MANUFACTURERS SUPPLYING THE FINEST QUALITY IRONMONGERY

Touch combine traditional skills with modern manufacturing techniques to produce the most beautiful, quality fittings, built to stand the test of time.

As well as specialist bespoke items, Touch supply over 1000 products, available in 23 different finishes to furnish high end residential and commercial properties, royal palaces, government houses, historic castles and stately homes.

Olaria, available from Touch Ironmongery

www.atouchofbrass.co.uk & www.olariabarcelona.com

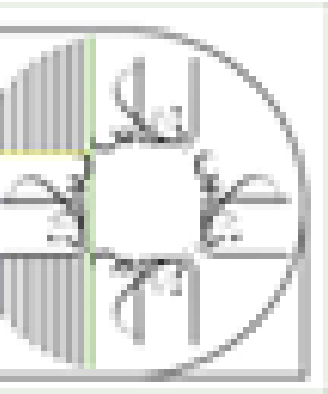

USING SMART WINDOW TECHNOLOGY TODAY COULD HELP BUILD THE HOMES OF TOMORROW

Our homes have become the places we work, relax, play and exercise. Unfortunately for many homeowners, the more time they've been indoors, the more their dream of a forever home becomes a realisation that they will probably need to move again or make renovations to achieve that dream.

Grant Sneddon, product manager at roof window manufacturer VELUX, believes that new homes should be designed to respond effectively to homeowners' every life stage. Here, Grant shares his thoughts on how integrating smart window technology into new build plans from the outset can help deliver homes that serve their owners for a lifetime.

At VELUX, we pride ourselves on providing high quality, adaptable products that can last our customers decades, and there's no reason why their homes shouldn't do the same. One of the simplest design considerations to factor into a long lasting, healthy home is the mix of glazing, and combining roof windows with vertical windows or patio doors ensures natural daylight will travel as far as possible into a room.

We recommend that vertical and roof glazing covers up to 15-20% of a room's floor space to allow for maximum daylight and ventilation that helps create a light and airy living space.

It's not just the amount of glazing that's important in creating a sustainable healthy indoor environment; how you open and close your windows should be easy too. We launched our smart-home roof window system VELUX ACTIVE with NETATMO to help create healthy living spaces by responding to both indoor and outdoor environmental factors.

The smart system uses sensors to continuously monitor the temperature, humidity and CO2 levels in the home and will automatically open or close VELUX roof windows accordingly to maintain a healthy indoor climate. All households benefit from a healthy living space and especially those that have children running around, or others where older people might not be able to reach their roof windows as freely as they used to. Homeowners can also download the VELUX ACTIVE smartphone app so they can control their roof windows from anywhere in the world.

VELUX ACTIVE is compatible with all of our VELUX INTEGRA® roof windows. The innovative window system comes with a pre-paired wall switch for manual activation and is available on all centre pivot and top hung* roof window models, making them suitable for practically every homeowners' needs.

It also comes with the option of adding blinds and shutters, both of which can be operated using the VELUX INTEGRA® wall switch or, if the two products have been integrated, the VELUX ACTIVE app.



Whether it's to allow little ones to have more fresh air indoors, home workers being able to control their roof windows from their home office, or retirees being able to remain independent as they get older, smart roof window technology is vital to helping people across all life stages enjoy their homes for longer.

For more information, visit www.velux.co.uk

*- VELUX INTEGRA top hung technology is only available in mains-powered operation.

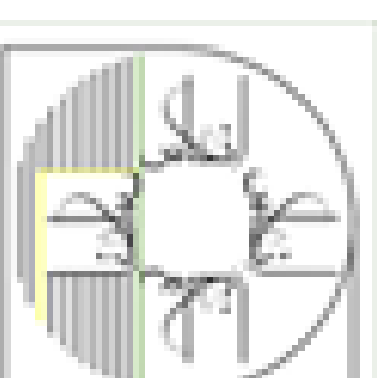
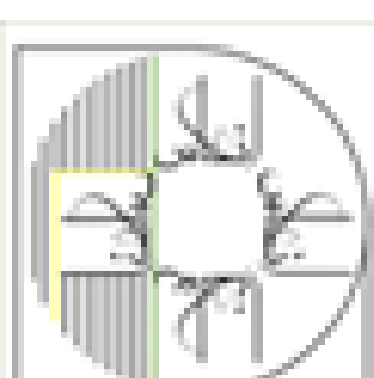

NEW SMART TECH ROOF WINDOW UPGRADE FROM VELUX® IS DESIGNED TO HELP INSTALLERS REAP THE BENEFITS

Leading roof window manufacturer VELUX® has introduced a new promotion which is set to make it easier for installers to promote the benefits of VELUX INTEGRA® to their customers.

Starting in August and running until the end of the year, homeowners purchasing VELUX INTEGRA® electric and solar powered roof windows* can receive a free VELUX ACTIVE with NETATMO kit worth £220. This complimentary upgrade will make it easier for installers to showcase the impact INTEGRA windows will have on their clients' projects.

VELUX INTEGRA® is an innovative system of roof windows, blinds and shutters that can be controlled with one touch of a pre-paired wall switch, with rain sensors automatically closing roof windows at the first sign of a downpour.

VELUX ACTIVE with NETATMO takes the INTEGRA® range to the next level, offering total indoor climate control. Smart sensors continuously monitor temperature, humidity and CO2 levels in customers' homes and adjust their roof windows to create a healthier indoor climate.

Windows can even be controlled when customers are on the go, thanks to the VELUX ACTIVE app, which is compatible with

voice-controlled virtual assistants such as Apple's Siri and Google Assistant.

The ACTIVE kit can be delivered to the property where the windows were installed and comes ready to fit and with full instructions included. This means that once it arrives, homeowners can install the kit themselves, saving installers time ahead of their next client project.

Installers can help customers take advantage of this offer until the end of December 2020, simply by creating a VELUX Rewards account and uploading their invoice. Approved purchases of VELUX INTEGRA roof windows will automatically generate an email with instructions to claim a free ACTIVE kit.

Up to £30 in VELUX Rewards per roof window will also be available, which can be spent with top-brand partners including M&S, Argos, TK Maxx, H&M and many more.

For more information, visit velux.co.uk/activeupgrade

**- One free VELUX ACTIVE kit will be offered per invoice where a purchase of VELUX INTEGRA® electric and solar roof windows has been made. Terms and conditions apply, see velux.co.uk/activeupgrade for more details.*

NEW SPECIALIST DOOR HARDWARE CATALOGUE!

It's here! Issued only every two years, now is the time for the latest ZEROplus catalogue & price list. Issue #23 is full of new specialist door hardware products, new product testing information, and



increased existing ranges. Some highlights are as follows.

- Specialist door seals – for fire, smoke and sound
- Pre-fabricated vision frames – square, rectangular and circular
- Fire rated louvres
- Fire & smoke tested intumescent Teardrop seals
- Finprotect Plus British Standard tested finger protection strips
- Rescue hardware – emergency door stops & pivot sets
- Breaksecure 3 star security euro profile cylinder range
- Elite series glass door patch fittings and locks
- Vast array of panic and emergency exit devices
- Largest range of door stays in the UK
- Grade 316 stainless steel gate fittings

To request a copy of our new 276 page catalogue, either visit our website at www.zeroplus.co.uk, or give us a call on 01785 282910.

FBLs FIRE BLOCK LOUVRE SYSTEM

ZEROplus



COMPLETE KITS COMPRISING INTUMESCENT FIRE BLOCK GRILLE AND STEEL LOUVRES FOR DOORS AND PANELS

- TIMBER FIRE DOORS UP TO 60 MINUTES INTEGRITY
- STEEL FIRE DOORS UP TO 240 MINUTES INTEGRITY
- 27 STANDARD SIZES FROM STOCK
- MILD STEEL OR STAINLESS STEEL LOUVRES AVAILABLE
- TO SUIT DOORS MINIMUM 44MM THICK
- NO MAXIMUM DOOR THICKNESS



THE FBLs CONSISTS OF AN INTUMESCENT FIRE BLOCK GRILLE ONLY 14MM THICK WHICH FITS WITHIN THE DOOR LEAF IN THE APERTURE, AND A STEEL TWO-PART LOUVRE SET WHICH FASTENS TO BOTH SIDES OF THE DOOR AND SANDWICHES THE INTUMESCENT BLOCK. IN THE EVENT OF FIRE THE INTUMESCENT EXPANDS 80 TIMES ITS OWN VOLUME TO FILL THE DOOR VOID PREVENTING THE SPREAD OF FLAMES.

Zero Seal Systems Ltd
Units 43 - 45 Ladford Covert, Seighford, Stafford, ST18 9QG, United Kingdom
Tel : +44 (0)1785 282910 E-mail : sales@zeroplus.co.uk

WWW.ZEROPLUS.CO.UK

Multi-Purpose Bin Lids: More Than Meets the Eye



Without Lid

With Lid

With Lid

With Lid

Top/Side/Diagonal

Top

Side

Diagonal

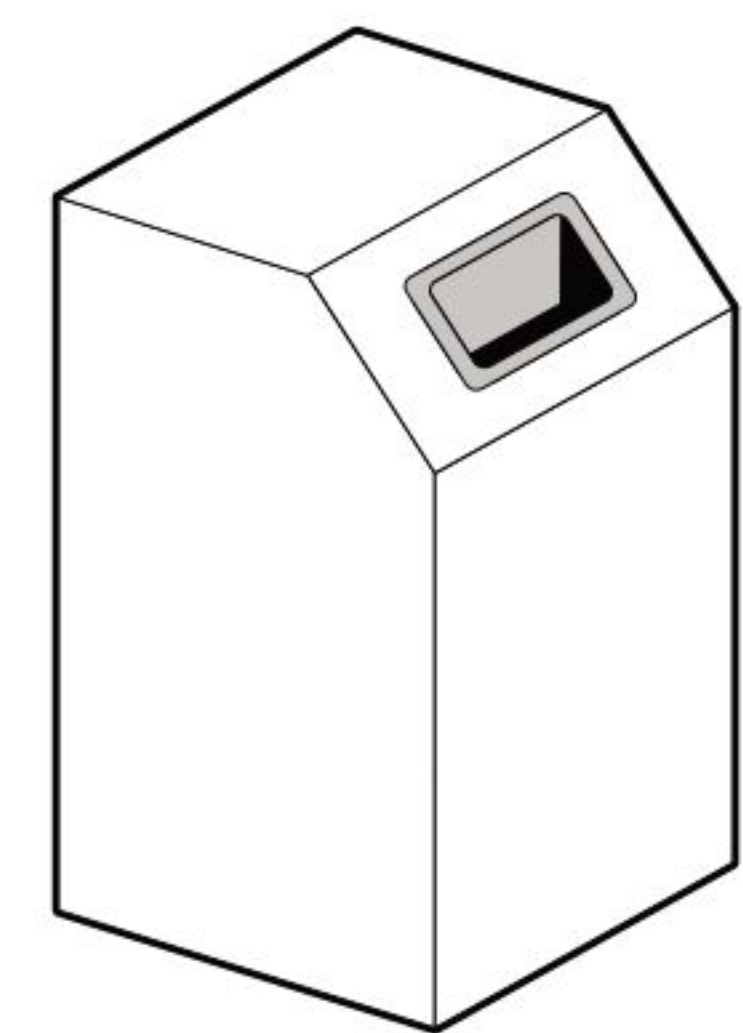
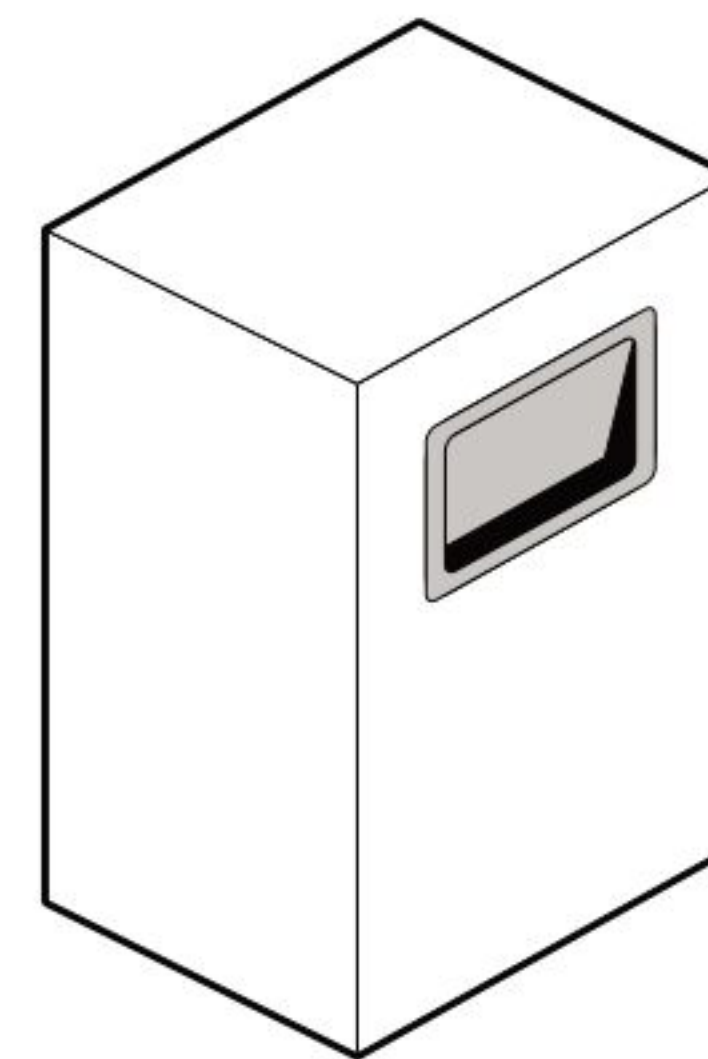
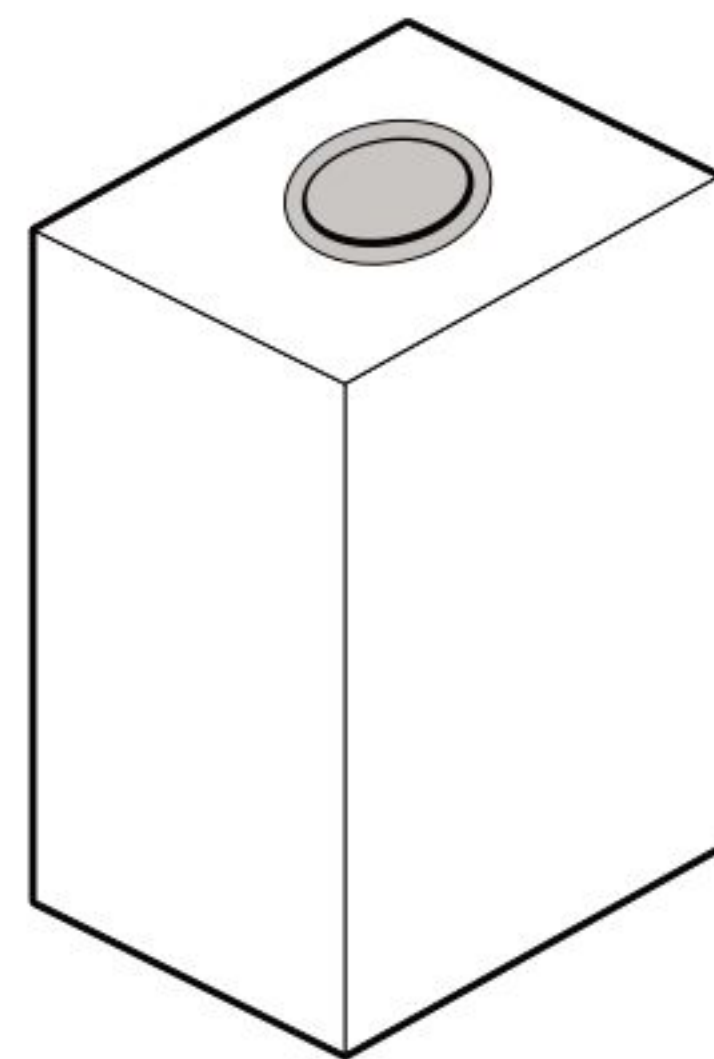
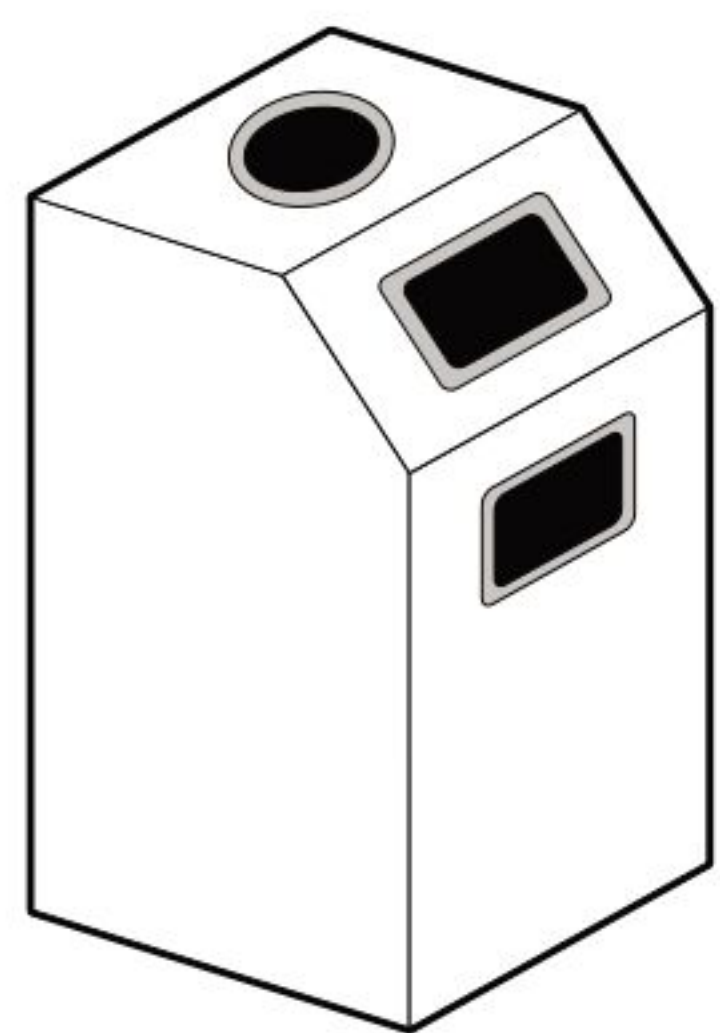

Bins are ubiquitous. If you think about all the places you find them, you very quickly come up with a lengthy list. In and around the home, of course, then offices, commercial kitchens, hospitality and entertainment venues, spas and gyms, public transportation and so on.

And then there are all the different purposes bins are put to. Some for general waste, some for food waste, and increasingly common, different bins for different categories of recyclable waste. And then there are bins for sanitary and hazardous waste, too, such as those found in public toilets or the medical waste bins in hospitals and clinics.

Bins in so many different places for so many different purposes mean they also come in all manner of different shapes and sizes. And so too do bin lids.

It is easy to take what a bin lid is and what it does for granted. Reflecting the wide variety of types and uses, Sugatsune manufactures more than 50 different multi-purpose bin lids and covers. Each type is meticulously designed and precision engineered to be a cut above the ordinary in terms of style, function and reliability.

All of our bin lids and covers are made of high quality stainless steel with an emphasis on pristine appearance as well as durability. One thing that makes the Sugatsune range stand out from other vendors is our manufacturing process. We have invested significantly in tooling capabilities that allow us to produce all of these different products in large volumes with an impeccable degree of precision and consistency. By contrast, many competitors still finish bin lid components by hand, which leads to slight variations and long lead times for bulk orders.

We also use techniques such as stud bolt welding that not only creates an attractive and durable finish, it also improves safety. Having all the edges on all lips around lids and covered smoothed precisely in this way avoids the risk of cut fingers.

Our hinged bin lids range includes both horizontal and vertical flaps. Our top-mounted horizontal lids are available in both round and square varieties, ranging in size from 106mm in diameter to 276mm. Our side-mounted vertical lids are larger and rectangular in shape, ranging from 182mm in width to 310mm, and come in top-opening,

bottom-opening and dual side-opening options.

Many of our lids benefit from being fitted with a balance weight and our patented soft close damper technology, which ensures the flap closes automatically but also smoothly and silently, avoiding the risk of trapped fingers.

In addition, our top-opening vertical lids, which are conventionally pulled forward top open. can be customised by adding a magnetic catch to hold them closed and a push-to-open mechanism which means no external handle is required. We also offer a lockable vertical lid, a useful security feature for any external bins to mitigate against things like fire and bomb risks.

As well as hinged lids, we also manufacture open bin covers. Again, these come in a variety of shapes and sizes. A common use for covers with different size apertures is to sort waste for recycling, as different covers will only allow objects of a certain size to pass through. One specific adaptation of our open bin covers is a funnel designed for disposal of liquids, for example throwing away drinks in a restaurant, which can be paired with additional components such as a PVC hose and strainer.

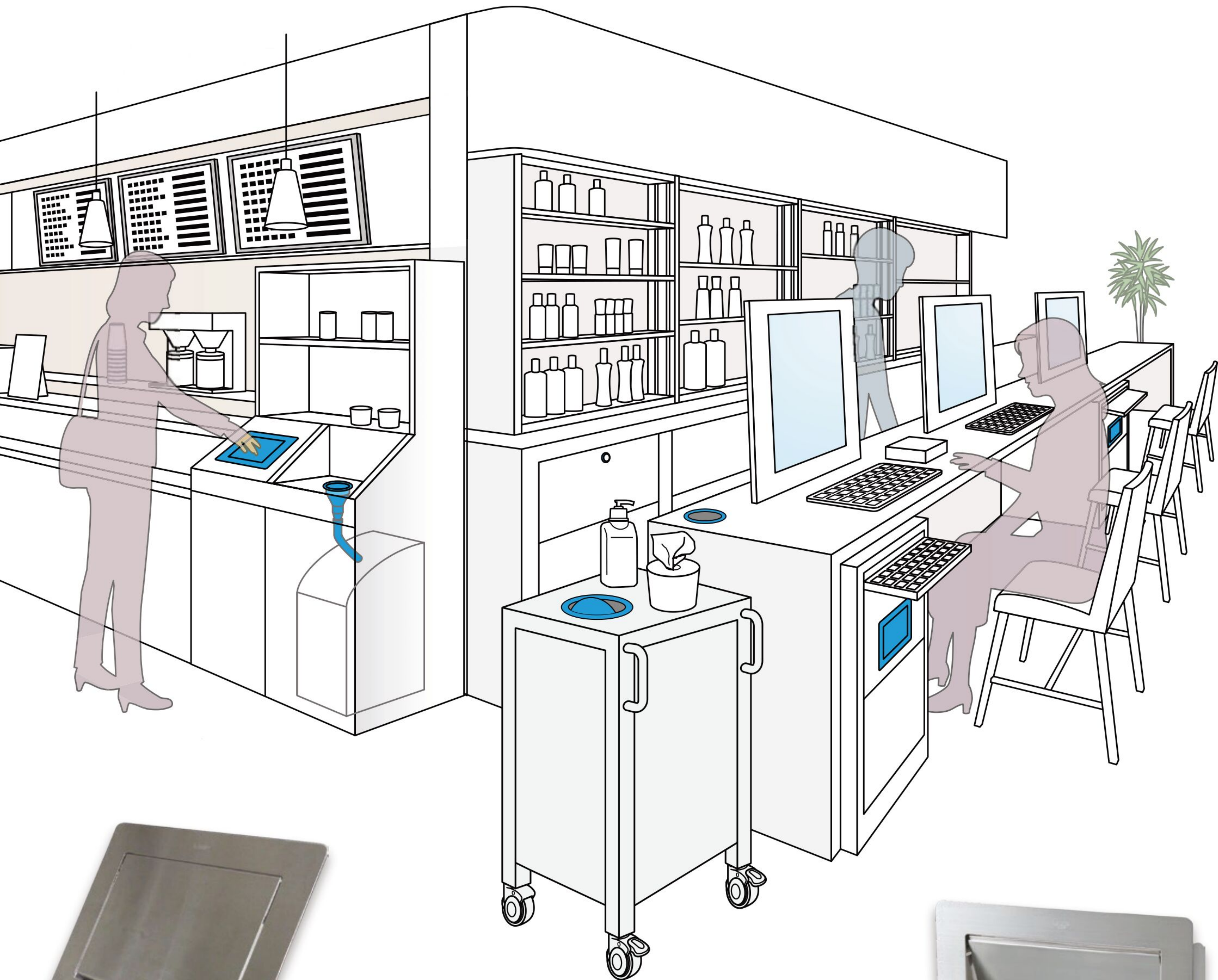

■ ■
SUGATSUNE
 ■ ■

Japanese manufacturer of
LAMP® and **Zwei L**®
 branded products

FURNITURE, ARCHITECTURAL, MARINE AND INDUSTRIAL HARDWARE

Unit 635, Wharfedale Road, Winnersh Triangle, Wokingham, RG41 5TP

آموزشگاه انعکاس منبع جدیدترین اطلاعات، مقالات و دوره‌های آموزشی دکوراسیون داخلی

🌐 Enekas.Academy

📷 Enekas.Academy

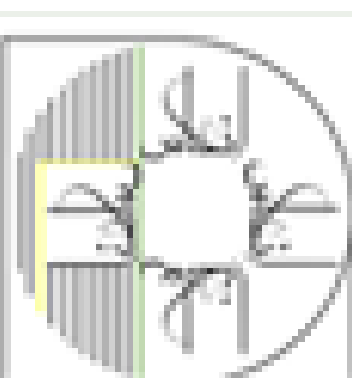
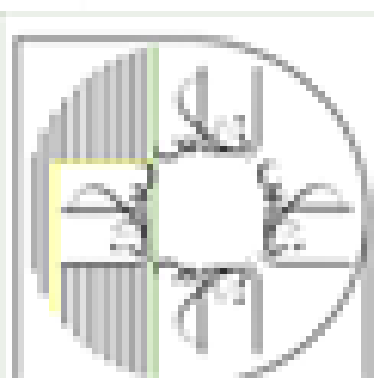

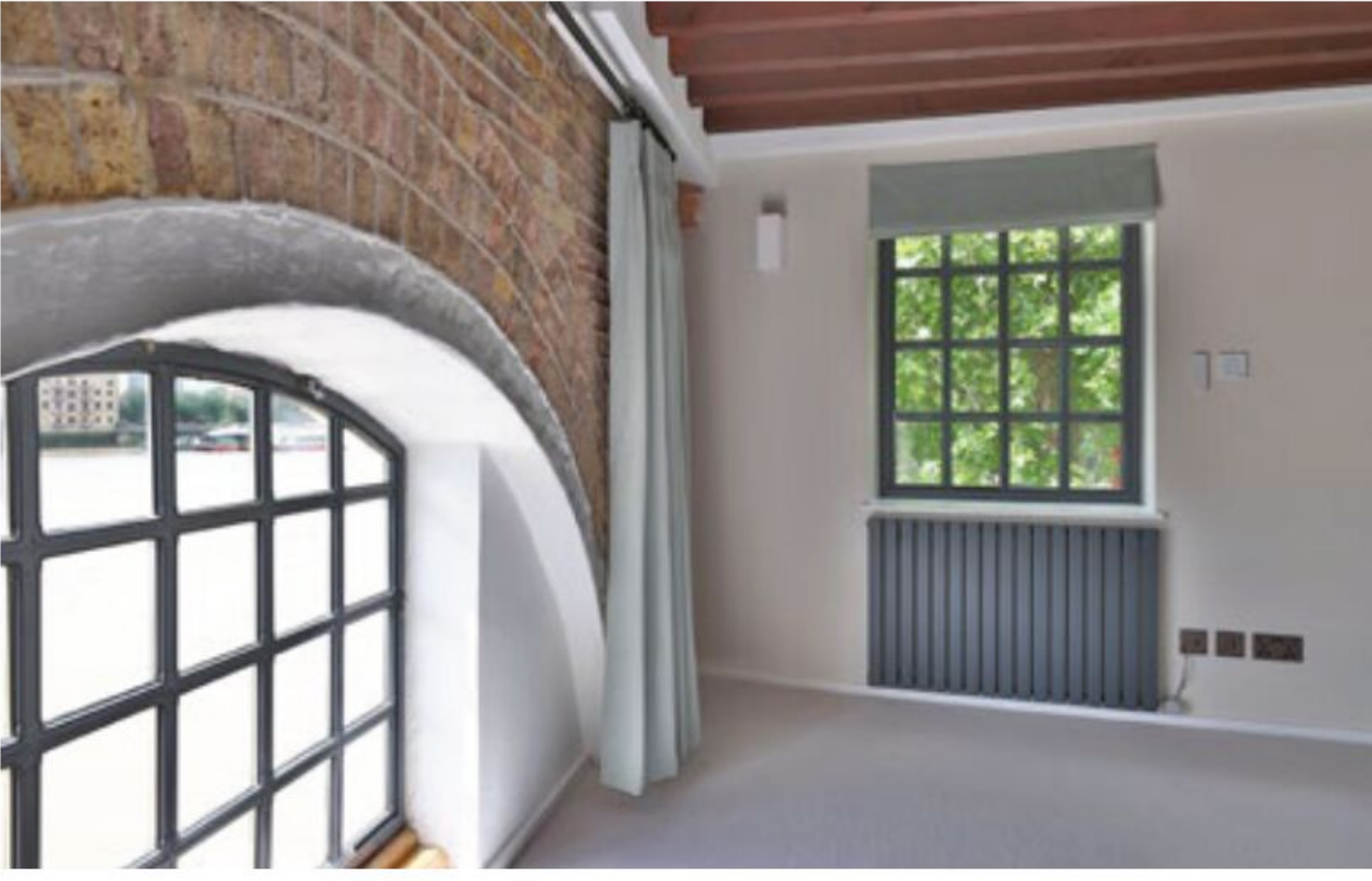

CONVERTED WAREHOUSE INTO LUXURY LIVING WITH SELECTAGLAZE SECONDARY GLAZING

The Grade II Listed Aberdeen Wharf, located in Wapping, East London; has stood ground to many changes to the area over the years. With the area's proximity to the river Thames, it had a strong historical maritime link well into the 20th century, which can still be seen today through the local architecture.

Fortunes changed in the 1980s, with the redevelopment of Wapping by the London Docklands Development Corporation, which saw a number of the standing warehouses, such as Aberdeen Wharf, converted to luxury apartments; one of which has recently had further modifications bringing it up to 21st century standards.

Absolute Project Management was approached by a resident, to help reconfigure, redesign and renovate the 2-floor apartment. With views over the Thames one side, and overlooking Wapping Rose Gardens on the high street, the resident wanted extra peace and quiet, as London itself is a noisy city.

Four windows were identified as requiring Selectaglaze units; one of which was facing internally into the building foyer. The Series 10 2-pane horizontal sliders were specified for three of the windows and a smaller one treated with a Series 30 lift-out – Absolute chose fluted glass to provide privacy and as an additional aesthetic enhancement. To compliment the black framed primary windows and to contrast with the exposed brick work, the secondary glazing was powder coated in a matt slate grey (RAL 7015). Glazed with 6.8mm laminated glass and installed with a 150mm-200mm cavity, the noise insulation has been improved, as well as increasing heat insulation. One of the openings required splayed timbers and crafting on site by the installation team, to ensure a tight fit was created to maximise the benefits and performance levels.

For further information, please contact Selectaglaze on 01727 837271/e mail: enquiries@selectaglaze.co.uk or visit: www.selectaglaze.co.uk



selectaglaze™

Secondary Glazing

Secondary glazing seamlessly integrated to make your property:

Warmer

Quieter

Safer



Grade II* Listed Blue Mills, Essex

- Reversible adaptation for Listed and heritage buildings
- Exemplary thermal retention and draught insulation
- Most effective method of sound proofing
- Makes properties more energy efficient
- Bespoke treatments

T: 01727 837271

E: enquiries@selectaglaze.co.uk

www.selectaglaze.co.uk

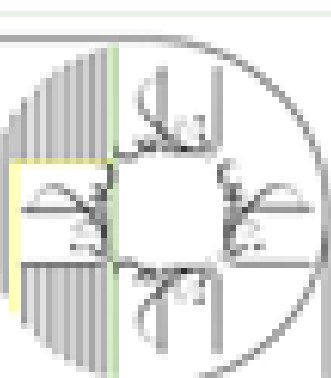
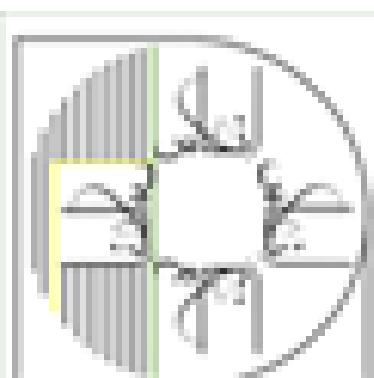

TRADITIONAL TIMBER WINDOW AND DOOR SPECIALISTS

The Sash Window Workshop specialise in the replacement and repair of traditional, timber windows and doors. They work hard to replicate the proportions and designs of historic windows, whilst incorporating the latest manufacturing techniques.

The company offer a wide range of services, including new timber windows and doors, with a supply and fit, or supply only service; replacement sashes into existing window frames; draught proofing; and secondary glazing.

New windows and doors are manufactured at their workshop in Berkshire to the highest standards and come with extensive guarantees. The materials used enable them to produce windows to the highest specifications, giving the best possible performance and combining minimum maintenance with maximum lifespan.

The Sash Window Workshop pride themselves on providing tailor made solutions to suit their clients' requirements. Their craftsmen and installers are experts in their field, and will provide you with beautifully made, thermally efficient windows and doors.

Established in 1994, The Sash Window Workshop has extensive experience collaborating with architects on a wide range



of period properties. They understand the importance of completing the required work within the timeframe of your project and will work with you to ensure that deadlines are met.

The company are proud to provide both a high quality product and excellent customer service, reflected in the fact that approximately half their orders every year come from recommendations or previous customers. They are also FSC® Certified, FENSA registered and members of the Which? Trusted Trader scheme.

To obtain a free quotation, contact The Sash Window Workshop on: 01344 868 668 or email: info@sashwindow.com. You can also visit their website: www.sashwindow.com



High Quality, Traditional Timber Windows and Doors

Providing Tailor Made Solutions For Your Project. Period Property Experts.

Supply Only, Supply and Install, Draught Proofing and Overhaul.



01344 868 668

www.sashwindow.com



**THE SASH
WINDOW
WORKSHOP**

THE NEW FRELAN CATALOGUE 42

3000 products, 38 finishes

The choice is yours

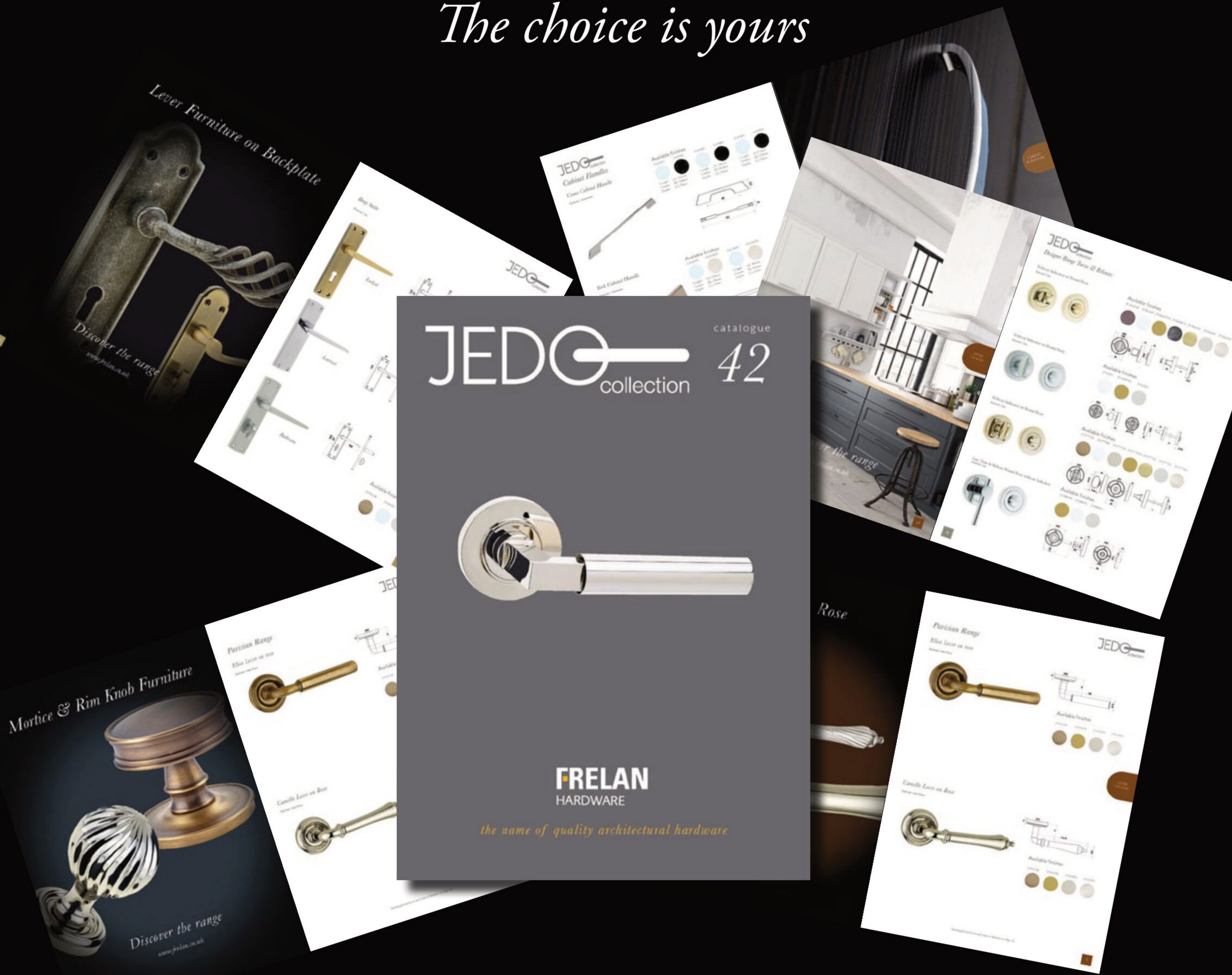

REQUEST YOUR COPY TODAY

T:020 8648 1500 Email:sales@frelan.co.uk

Or Download From Our Website

www.frelan.co.uk

Discover the range

آموزشگاه انعکاس منبع جدیدترین اطلاعات، مقالات و دوره‌های آموزشی دکوراسیون داخلی

 Enekas.Academy

 Enekas.Academy

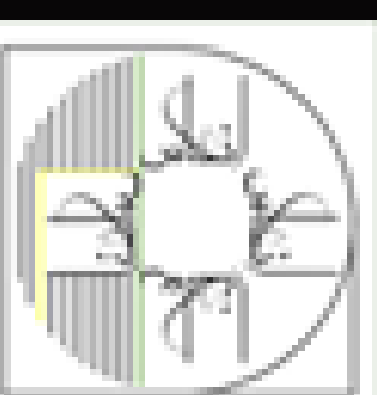
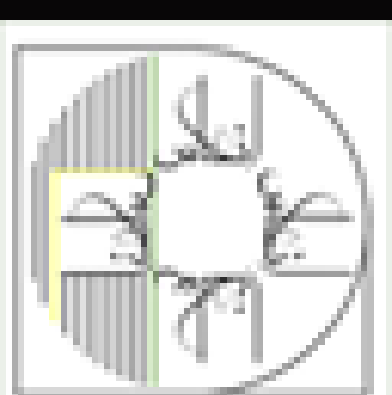

COMMITTED TO EXCELLENCE

DEFINING SPACES THROUGH ARCHITECTURAL GLAZING SOLUTIONS

Since 1985, Metal Technology has been defining spaces through its architectural glazing solutions and has grown to become one of the UK and Ireland's leading designers and suppliers of bespoke aluminium window, door, curtain wall and solar shading systems for commercial and residential applications.

Committed to excellence in all aspects of sustainable product design, customer service and technical support, the company has become a trusted partner of fabricators, developers, contractors and architects.

Metal Technology's product portfolio encompasses over 30 window, door, curtain walling, brise soleil and louvre systems. Its Thermally Enhanced (Hi+) portfolio offers the designer a wide and diverse choice of profiles that provide structural integrity, weather performance, thermal enhancement and security.

TECHNICAL SUPPORT

Metal Technology offers a comprehensive design and specification service to architects, developers and main contractors through a team of architectural advisors. Tailored specifications can be provided online with NBS standards, supported with CAD details and performance data as well as BIM family models for integration into construction drawings.

EDUCATION

Metal Technology has vast experience of providing fenestration solutions for over a 1000 universities, colleges and schools throughout the UK. In recent years, student accommodation has become one of the fastest growing segments of the construction industry and is an area where the exceptional properties of the various Metal Technology systems come to the fore, delivering quality, functionality, performance, security and stunning aesthetics. Recently completed student accommodation projects include the award winning Horizon Heights development in Liverpool, Belaton House and Bailey Point in Bournemouth and 123 York St in Belfast.

RETAIL

From leading supermarkets and shopping centres to high spec showrooms, Metal Technology's products have provided designers with the flexibility to combine aesthetic architectural statements with value engineered practicality, performance and durability.

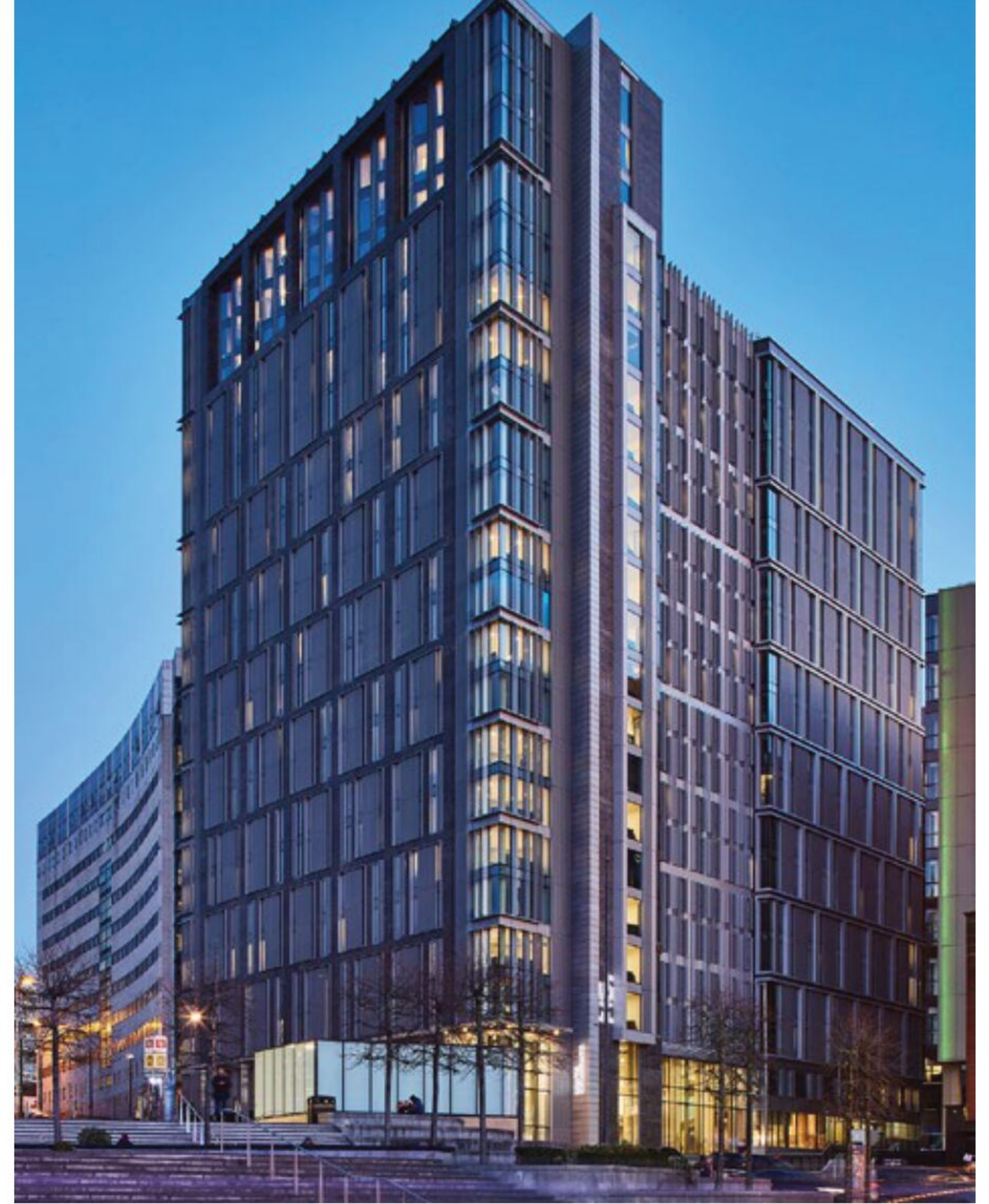

LEISURE

Metal Technology has supplied its high-performance systems to major new hotels across the UK and Ireland with involvement in the Grand Central Hotel, AC Hotel by Marriott, the Maldron and Hampton by Hilton as well as Jurys. The company has also completed major leisure projects such as Aintree Racecourse and the British Golf Museum in St. Andrews.

HEALTHCARE

From Glasgow's Victoria and Southern General Hospitals to its Maryhill Health Centre, Metal Technology has applied its expertise in close collaboration with designers to deliver financially economic yet technically robust solutions.

COMMERCIAL

Contracted for many commercial schemes in the UK, Metal Technology recently supplied their architectural glazing systems for a number of recently completed, award-winning developments: CDE Global headquarters in Cookstown, the prestigious 64,000 sq ft Victoria Gate commercial office building in Woking and the Aurora building in Bristol.

RESIDENTIAL

Signature apartment blocks in London, Belfast and Manchester are excellent examples of how Metal Technology's windows, curtain walling, sliding and bifold doors meet the aesthetic, security and thermal performance requirements of any building.

www.metaltechnology.com

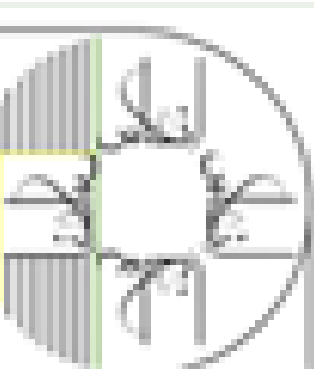

WHAT IS AVAXHOME?

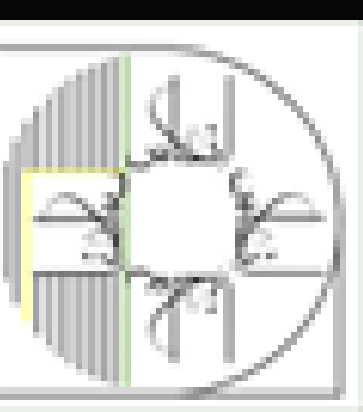
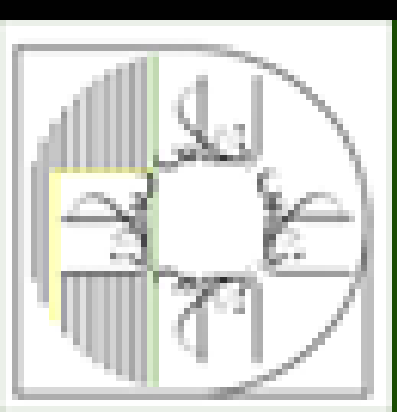

AVAXHOME-

the biggest Internet portal,
providing you various content:
brand new books, trending movies,
fresh magazines, hot games,
recent software, latest music releases.

Unlimited satisfaction one low price

Cheap constant access to piping hot media

Protect your downloadings from Big brother

Safer, than torrent-trackers

18 years of seamless operation and our users' satisfaction

All languages

Brand new content

One site

AVXLIVE ICU

AvaxHome - Your End Place

آموزشگاه انعکاس منبع جدیدترین اطلاعات، مقالات و دوره‌های آموزشی دکوراسیون داخلی

 Enekas.Academy

 Enekas.Academy

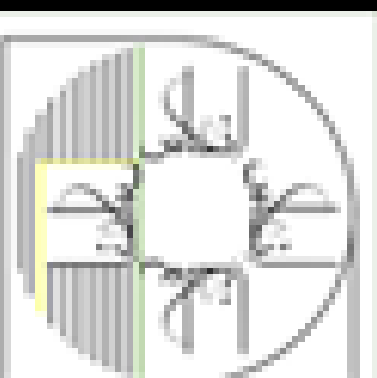
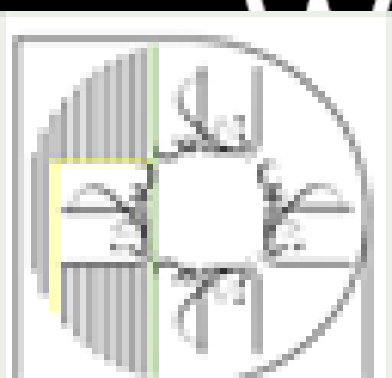



MORI HOSSEINI STUDENT UNION, EMBRY-RIDDLE AERONAUTICAL UNIVERSITY

STRUCTURALLY EXPRESSIVE STUDENT UNION CREATES A "CITY WITHIN A CITY" ON THE DAYTONA BEACH CAMPUS

Inspired by the gracefulness of birds in flight, the Mori Hosseini Student Union at Embry-Riddle Aeronautical University, designed by ikon.5 architects, is an expression of the University's mission to teach the science, practice, and business of aviation and aerospace. Located at the front door to its Daytona Beach campus, the building's gently soaring form expressing flight creates an iconic identity for the University and embodies its student's values of fearlessness, adventure, and discovery.

Programmatically, the 177,000-square-foot student union building is an aeronautical athenaeum combining social learning spaces, an events center, club offices, student affairs offices, career services, dining, and the University library. A soaring, triple-height commons integrates the collaborative social and learning environments.

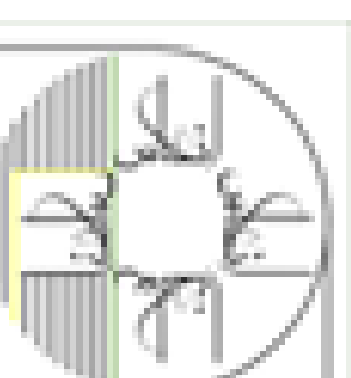
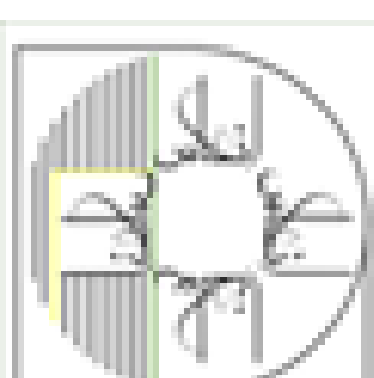

“

The top floor houses the university library which is set beneath a dynamic 200-foot arching skylight that opens to the sky.



The lounges, dining venues, group study rooms, clubs and organization offices, career services, student affairs, and the University library wrap the commons and culminate in a multi-story amphitheater that overlooks the commons and building entry. The amphitheater is a place to see and be seen. An event center that can accommodate up to 900 people is housed on the first floor. The top floor houses the university library which is set beneath a dynamic 200-foot arching skylight that opens to the sky. A roof terrace on the second floor allows students to gaze upon the adjacent runway of Daytona International Airport and beyond to rocket launches from the Kennedy Space Center at Cape Canaveral.

Creating this athenaeum of program spaces for students of aviation and aerospace technology within a building that characterizes fearlessness and discovery of flight has given Embry-Riddle an iconic main building that appropriately expresses their mission.

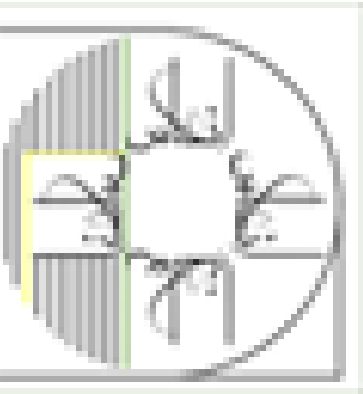



Key to embodying the ethos of Embry-Riddle in architectural form is the exuberant and creative structural steel expression that illustrates movement, flight, and aerodynamics both externally and internally. The curving bowed roof on top of the structure not only provides solar shading from the harsh Floridian sun but also invokes sinuous avian forms. The vertical, exposed struts convey a feather-like quality and are structural members that tie down the curved roof form from wind uplift, particularly, for hurricane resistance. The great, exposed double arches that wrap the exterior support the vertical roof struts at the shading overhang and signify the main entrances to the building. Internally, an exposed 200-foot curving steel arch bisects the middle of the plan and supports a glass roof above, allowing the students of aviation the ability to look skyward while inside. The building's architecturally exposed structural steel (AESS) is an integral design element and helps create an exterior and interior aesthetic that feels finished and dynamic.

The project commenced as an invited, national design competition to create a new student union for Embry-Riddle University that would transform the student experience on campus. The former student union was a small and outmoded facility that no longer supported that growing student enrollment and diverse student activities available at the university. The new Mori Hosseini Student Union strengthens the unique identity and programs for the students at this aeronautical university.

"It is an iconic centerpiece to the campus that is recognized as more than an architectural masterpiece," said Barry Butler, Embry-Riddle president. "It is the center of student life on our campus."

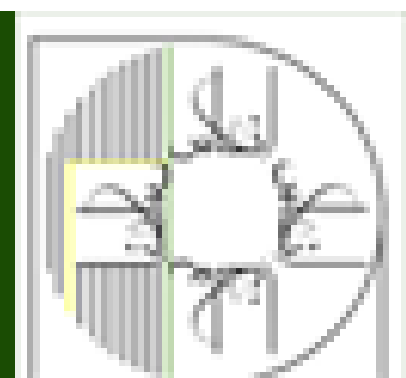
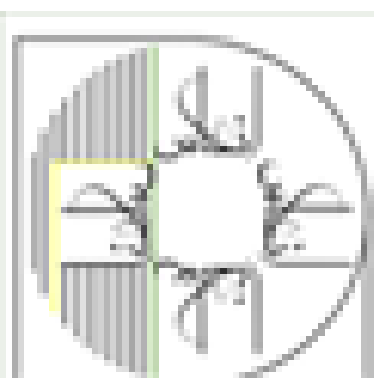

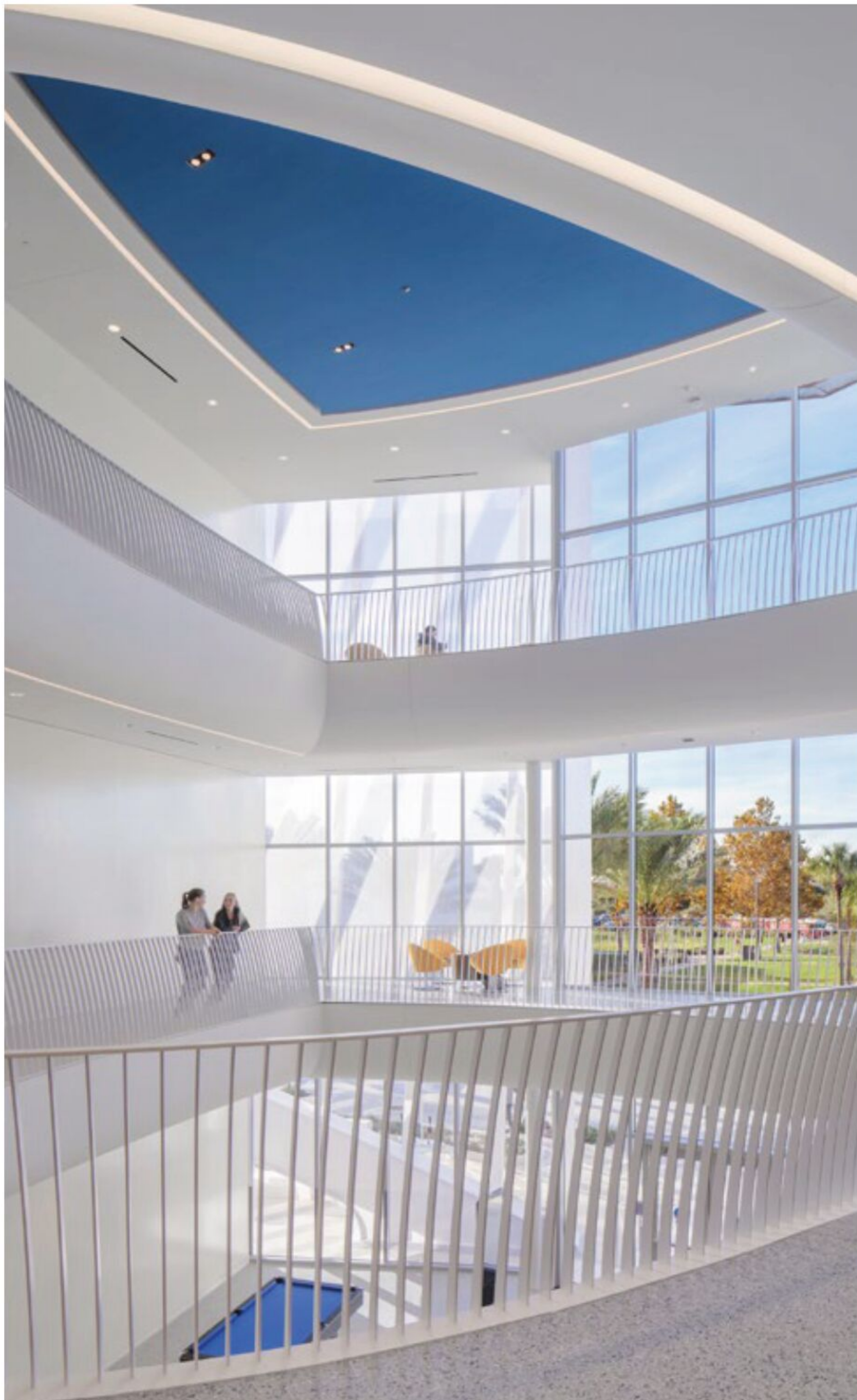

Project Data

Official Project Name: Mori Hosseini Student Union
 Location: Daytona Beach, FL
 Client: Embry-Riddle Aeronautical University
 Architect: ikon.5 architects - New York, NY and Princeton, NJ
 Structural Engineer: Thornton Tomasetti - Newark, NJ
 MEP/FP Engineer: OCI Associates - Maitland, FL
 Landscape Architect: Prosser - Jacksonville, FL
 Lighting Designer: Fisher Marantz Stone - New York, NY
 Contractor: Barton Malow Company - Orlando, FL
 Photography: Brad Feinknopf
 Drawings: ikon.5 architects
 Building Area: 177,000 sf

www.ikon5architects.com

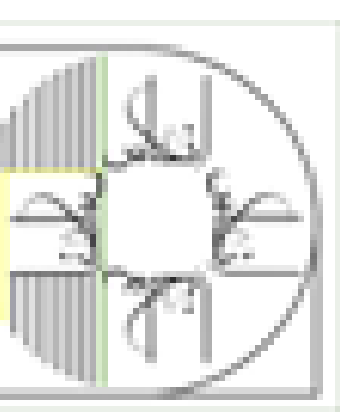
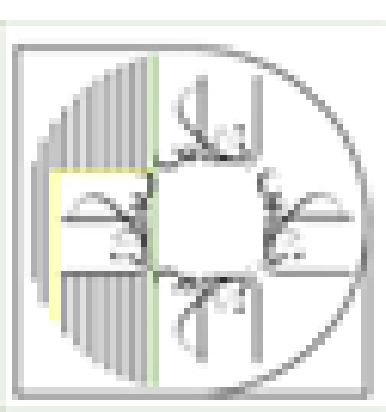

Gratnells

Flexible. Modular. Innovative.

Storage solutions for education,
health & social care

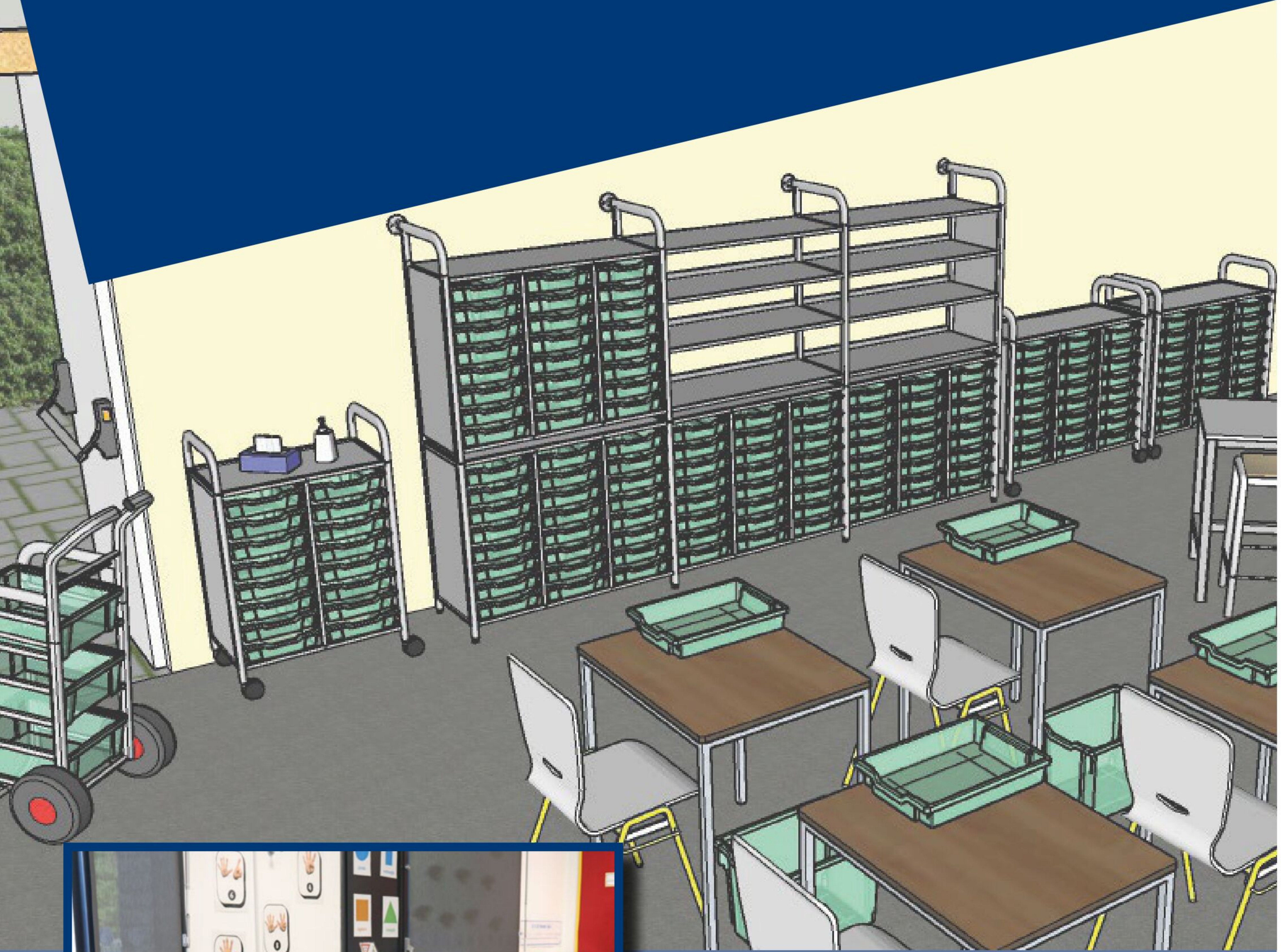

Our most popular educational storage system just got better.

Gratnells has introduced a range of Callero storage furniture and tray options incorporating BioCote® antimicrobial technology to help in the fight against the spread of surface bacteria.

Gratnells trays and Callero trolley models are now available in the SketchUp 3D Warehouse. You'll find them under the products tab when you search for Gratnells.

www.gratnells.com/classroom-health

www.gratnells.com

+44 (0)1279 401550

mail@gratnells.co.uk

آموزشگاه انعکاس منبع جدیدترین اطلاعات، مقالات و دوره‌های آموزشی دکوراسیون داخلی

 Enekas.Academy

 Enekas.Academy

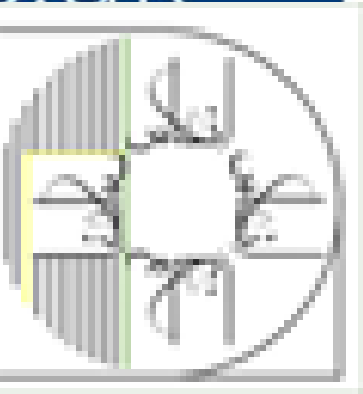

Planning learning spaces for the child's journey through school

It is well known and researched that the quality of the learning environment has a dramatic impact on pupils' learning, behaviour and social interaction. We know that some spaces can inspire pupils and encourage them to want to learn, whilst others can distract or disengage pupils. Our young people come from a variety of backgrounds but our schools are a place for them to feel safe, happy, confident and inspired. All teaching spaces should be attractive, inspiring and organised. They should excite pupils and staff.

There are many schools all around the world creating innovative learning spaces that are transforming the experiences of their pupils, often on limited budgets and with restricted resources. The desire for change in schools is strong and the Gratnells Learning Room concept offers the support necessary to consider how schools can achieve excellent outcomes.



Gratnells created the Learning Rooms project in 2012 to recognise and celebrate the benefits and advantages of different learning environments. Learning Rooms not only celebrates these environments, it also seeks to turn outmoded classroom models into places where both teaching and learning become inspirational, motivational and exciting. Through increasing evidence from academic research and personal testimony around the world, it's clear that the physical setting and arrangement of a classroom can have a profound effect on the way children learn, play and interact with each other and with the teacher.

Working with partners in technology, design, architecture and teaching we're helping to create a blueprint for the classrooms of today, tomorrow and



the future. A Gratnells Learning Room is a whole-systems plan conceived to deliver the best and most effective educational setting through enlightened design and layout both inside and outside the classroom.

We're not the first to recognise how important the physical place of learning is to a child's development, well-being, safety and sense of belonging. The inspirational work of the team behind 'The Third Teacher' is well documented and The Royal Institute of British Architects' 'Future Schools' published in 2015 makes fascinating reading. Gratnells products are already a key component within the classroom, but we want to help shape the places where our children are being educated. We want to create the best possible learning environments.

Find out more at learning-rooms.com and in Planning Learning Spaces magazine which is free to download and published three times a year with current thinking for architects, designers and school leaders. Gratnells is privileged to be part of a sector which has an opportunity to shape the future.

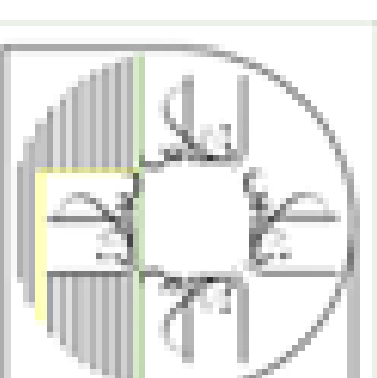
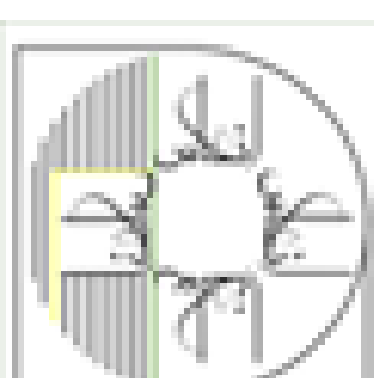



NEW ENTRANCE MATTING SPECIFICATION GUIDES

Maintaining a high level of hygiene, especially now, is a top priority and with entrance matting as your building's first line of defence, INTRAsystems has authored three new specification guides to help architects and interior designers.

The new downloadable guides detail key elements of entrance matting specification, sector specific considerations and product advice, alongside real-life case studies.

Separate guides are available for Schools, Colleges & Universities, Hospitals & Healthcare, and Road, Rail & Air to help architects and interior designers correctly specify entrance matting for these specialised sectors.

SPECIFICATION GUIDANCE

Subject to frequent intense footfall, with multiple entrances and often tightly managed budgets, entrance matting specifications for these sectors are some of the most difficult specifications to get right.

Understanding the traffic volumes and how the different entrances will be used is the very first consideration.

For example, hospital entrance matting needs to be easy to clean and capable of withstanding heavy wheeled loads, so a heavy-duty recessed aluminium matting system is essential. Creating a zonal entrance matting system in healthcare environments will also help retain the maximum dirt and moisture from shoes and wheels.

Whereas universities battling to attract new students might want to use their primary entrance matting to make a bold design statement with creative use of colour and pattern. Entrance matting inserts are available in multiple colours and logos can also be incorporated into the design.

Cycle entrances or doors from muddy school sports fields will benefit from a larger walk-off area using a combination of fibre and rubber inserts or even a more aggressive bristle brush insert.



However, a simple fibre solution may be adequate for less used, secondary entrances.

By using a combination of inserts you can create a range of complimentary entrance matting solutions using a single product.

STANDARDS AND LEGISLATION

Aside from the aesthetics, there are also several standards and regulations your entrance matting specification will need to satisfy including BS 7953:1999, which advises on the selection, installation and maintenance and BS 8300-2:2018 which covers accessibility.

All this and more is covered in the new Entrance Matting Specification Guides from INTRAsystems.

Available for free download at: intrasystems.co.uk/guides

+44(0)1425 472000
info@intrasystems.co.uk

www.intrasystems.co.uk

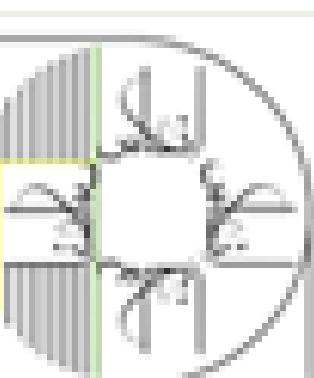

INTR.
SYSTEMS

Think outside the box

Manufacturing high quality entrance matting for discerning architects and interior designers since 1977

[Download Brochure](#)

آموزشگاه انعکاس منبع جدیدترین اطلاعات، مقالات و دوره‌های آموزشی دکوراسیون داخلی

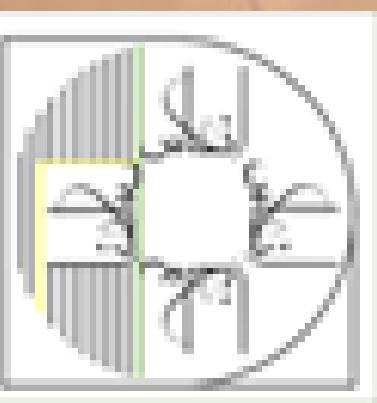
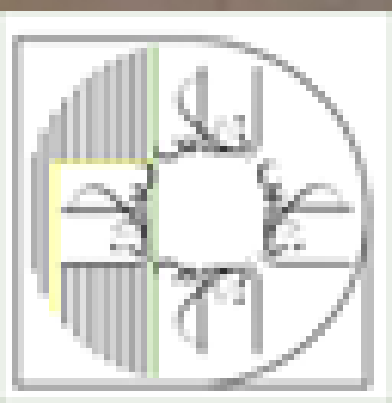



PLAY IT YOUR WAY WITH STUDIO MOODS

AWARD WINNING STUDIO MOODS IS THE OFF-THE-SHELF BESPOKE LVT SOLUTION FROM IVC COMMERCIAL, MAKING ONE-OFF FEATURE FLOORS MORE AFFORDABLE

Using nine geometric shapes, including four new XL formats over the original collection, combined with wood, stone and colour looks, Studio Moods presents 107 off-the-shelf QuickShip patterns that make it fast and easy to select a floor personalised to your project. Alternatively, you can use the 69 building blocks used for all QuickShip patterns to create your own design or go completely bespoke across 160 looks from just 75m².

From classic chevron and herringbone in surprising stone effects, through to patterns involving multiple formats, Studio Moods is all about versatility and creativity. Wood combined with stone, giant hexagons in solid colours next to dark oak; this is an LVT collection that brings personality to workplace, retail, hospitality and leisure, PRS and PBSA projects.

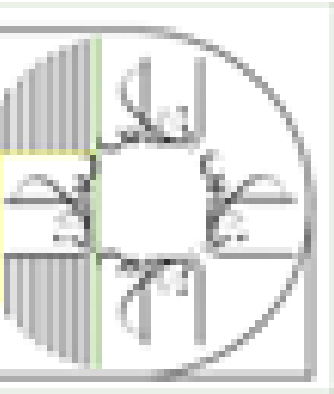

“

From classic chevron and herringbone in surprising stone effects, through to patterns involving multiple formats, Studio Moods is all about versatility and creativity.

“The original Studio Moods collection has proved itself as the ideal solution for creating stunning feature areas in a wide variety of projects,” says David Bigland, managing director, IVC Commercial. “Now with the new Studio Moods, we’ve refined the concept, so designers have access to a wider variety of patterns, bigger scale and new wood, colour and stone looks; all easily and quickly accessible from stock through our QuickShip programme.”

Using IVC Commercial’s 55 specification ensures that Studio performs wherever you choose to install it. Suitable for receptions, breakout zones and feature areas; as well as anywhere else that demands style and performance; the floor is durable and easy to maintain, efficiently made in Belgium using renewable energy and features 30% recycled content.

For further information, www.ivc-commercial.com

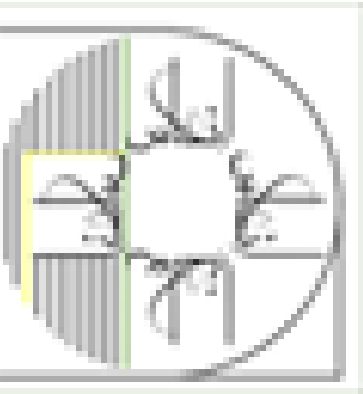
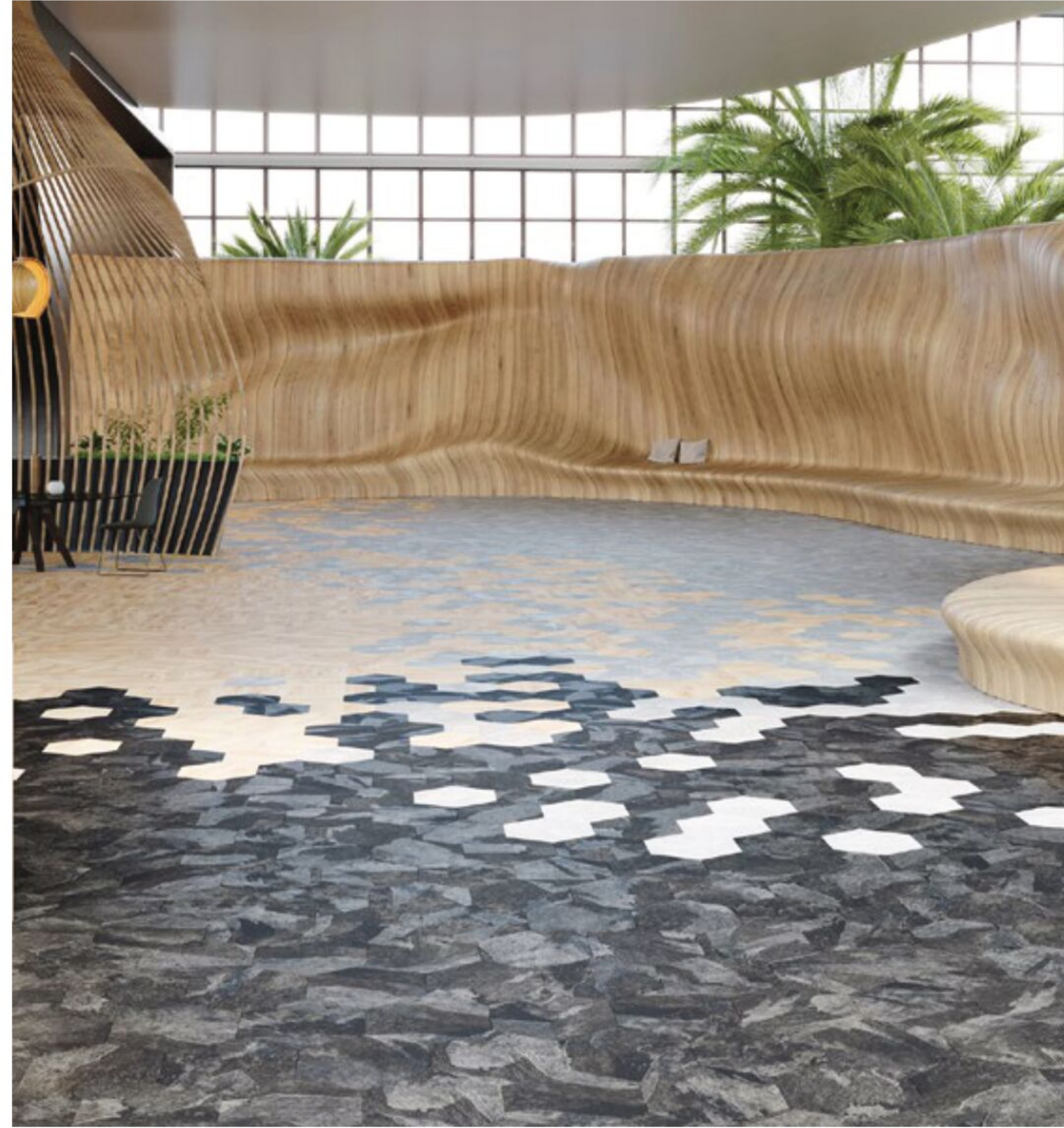

WOOD THAT WORKS

One of the recent residential projects from Havwoods is this beautiful city centre home located in the heart of London. Transformed into a modern interior that is both neutral and contemporary, this striking apartment underwent a full refurbishment, turning a large house into three separate dwellings.

The brief was to create a modern interior that is both spacious and up-to-the-minute, whilst allowing new homeowners to incorporate their own accents of colour and style. The project is characterised by bespoke cabinetry, striking shelving, statement lighting and the stunning Amendo floorboard from the Havwoods Venture Plank collection. With the flooring playing a key role in the overall look of the project, the result is a sleek, light-toned surface that is the perfect backdrop to this modern home.

The Amendo floorboard is used throughout this spacious setting, which is crafted with aesthetic qualities and backed by a superior high-quality birch ply to ensure a greater level of stability. The subtle warmth of this flooring was selected to showcase the beautiful natural textures in the wood. The Venture Plank Amendo board also has a tongue and groove fit profile with bevelled edge, making it suitable for use in conjunction with underfloor heating.



Combining modern-day designs and an ever-expanding international portfolio of products, the pioneering Havwoods brand sets the benchmark for superior quality wood flooring for both the residential and commercial markets.

www.havwoods.com

MOVE INTO THE LIGHT WITH EDGE LIT FROM MILLIKEN

Edge Lit is a bold new carpet tile and plank collection from Milliken, offered in 12 radiant colours ranging from vivid brights to rich neutrals and available in both a plank and tile format. It is inspired by the transformational and delineating attributes of light, such as a prism transforming sunlight into a splendid rush of colour or a black light exposing points of the spectrum. The collection is bright, graphic and uplifting, providing the perfect elements to transform a workspace to inspire, excite and motivate.



The impulse behind the collection was to help create invigorating workspaces that could stimulate imagination, new thinking and reignite workplace creativity to help with the transition back to work. Also to offer employees who have been working from home during lockdown, a place where people can come together – responsibly - to collaborate. Edge Lit helps to create a mood of positivity and promote mental well-being. The collection has been created by the Milliken design team to build a unique interior concept every time by coordinating with other Milliken collections through mixing textures and combining finishes. The Edge Lit collection with its various shapes, patterns and colours can be used to define zones and map out areas to facilitate responsible collaborative working (a fundamental aspect of work much missed by many during lockdown).

For further information visit www.millikencarpets.com

ORGANOWOOD®



01. PROTECTION
FORMS A WEATHER-RESISTANT FLAME & HOT PROTECTION



02. REPELLENT
FORMS A WEATHER-RESISTANT DIRT & WATER REPELLENT



03. CLEANER

EXTERIOR WOOD PROTECTION

FOR MORE ATTRACTIVE AND DURABLE WOOD

01.
ROT & FLAME PROTECTION

02.
DIRT & WATER REPELLENT

03.
ORGANIC CLEANER



01296 323770

www.organowood.co.uk

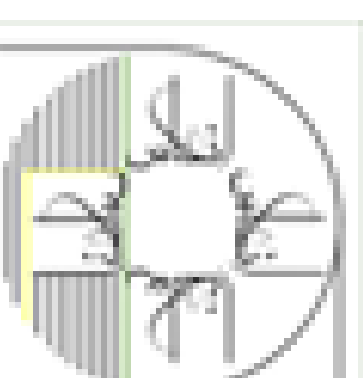
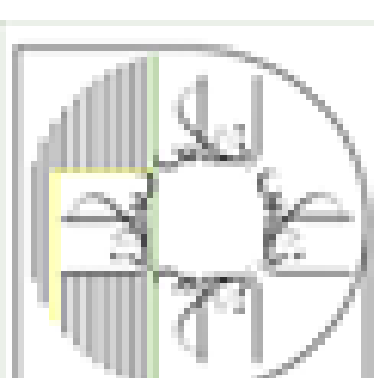

Hardwood Flooring

*bespoke finished
to complement
your designs*

☎ 01462 486586

✉ info@roversflooring.co.uk

🌐 www.roversflooring.co.uk

33 Jubilee Trade Centre,
Jubilee Road, Letchworth,
Hertfordshire SG6 1SP

ROVER'S
F L O O R I N G

PRODUCERS, IMPORTERS & DISTRIBUTORS

آموزشگاه انعکاس منبع جدیدترین اطلاعات، مقالات و دوره‌های آموزشی دکوراسیون داخلی

🌐 Enekas.Academy

📷 Enekas.Academy

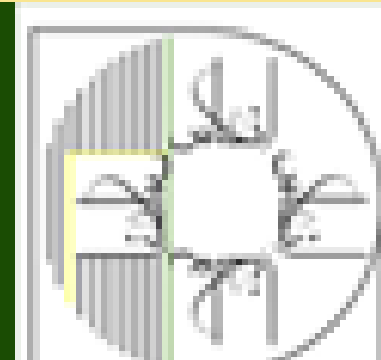
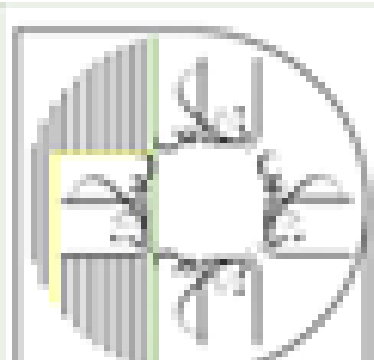



IVC EMBRACES OPENNESS AT AIB CORPORATE BANKING

IN THE HEART OF DUBLIN'S CENTRAL BUSINESS DISTRICT, THE OFFICES OF AIB CORPORATE BANKING HAVE BEEN TRANSFORMED TO EMBODY THE COMPANY'S VALUES, WITH LVT FLOORING FROM IVC USED EXTENSIVELY THROUGHOUT

Occupying seven floors of office space, AIB Corporate Banking called in the expertise of RKD, a leading international design firm to create an interior that reflected the company's values of openness, collaboration and transparency over a total area of 14,000m². For common areas, the canteen, tea stations, meeting areas and board rooms; RKD has used wood-effects from IVC's Moduleo 55 high-performance LVT specification to deliver a floor that gives an authentic look with the function needed for demanding areas.

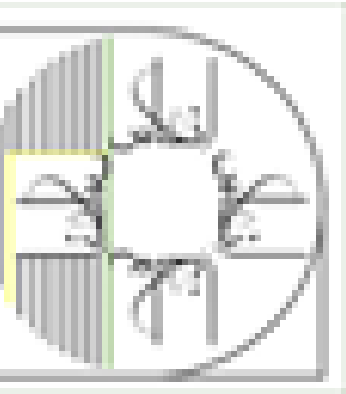

“

RKD has created a floor that works to enhance the organic, open feel of the interior.

Using a mix of standard planks in Moduleo 55 Woods and the Staggered Columns 203 design from the innovative Studio Moods concept, RKD has created a natural looking floor with additional design features. Using Studio Moods to bring added visual impact in meeting rooms and a feature inset in common areas that complements the vertical panels of natural plants, mosses and ferns used to divide areas; RKD has created a floor that works to enhance the organic, open feel of the interior.

Featuring a 0.55mm wear layer, IVC's Moduleo 55 LVT construction is the manufacturer's top-of-the-line specification. Delivering faultless performance in busy commercial spaces, with the additional protection of Protectonite® PUR for a surface that resists stains and remains easy to clean, it's a floor that can be specified for busy areas with complete confidence. Available in glue-down and click, Moduleo 55 Woods comes in 40 authentic looks each with a textured surface that adds to the realism.

A total of 1,460m² of IVC Moduleo 55 Woods and Studio Moods Staggered Columns 203 in a variety of decors were used at AIB Corporate Banking. The refurbishment was carried out by Structure Tone, a global construction management and general contracting provider.

For more visit ivc-commercial.com

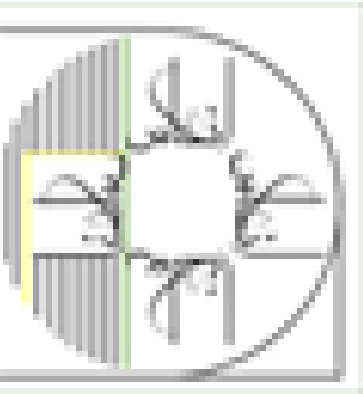



Learn something new, every day.

At Millboard, we're dedicated to helping you create innovative spaces. Now we're bringing our knowledge and expertise online.

Developed with you in mind, the new Outdoor Design Hub is home to unique information, inspiration and CPD-accredited courses, helping you achieve the results you want, faster.

The Outdoor Design Hub. Your go-to space for knowledge and inspiration.

Learn more at millboard.co.uk/outdoor-design-hub

Outdoor
Design Hub

from millboard
Live. Life. Outside.

آموزشگاه انعکاس منبع جدیدترین اطلاعات، مقالات و دوره‌های آموزشی دکوراسیون داخلی

 Enekas.Academy

 Enekas.Academy

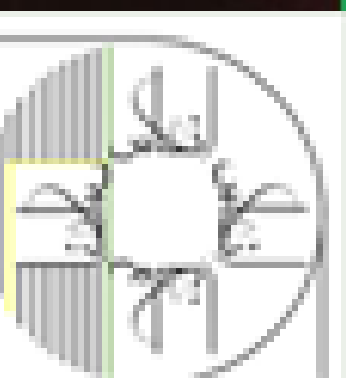
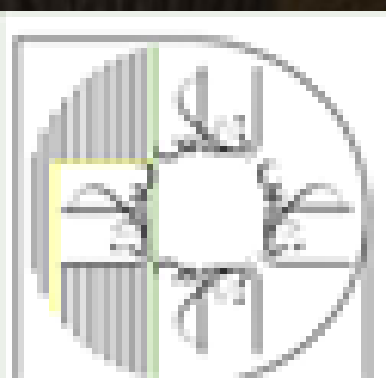

Specify CFA members and

MINIMIZE COSTLY FLOORING FAILURES



QUALITY BY ASSOCIATION



MARKS &
SPENCER

Only Specify
CFA FLOORING
Contractor Members

Specifying a CFA member for your next flooring project could mean the difference between success – or a flooring failure. Most of the UK's largest and best known Manufacturers, Distributors, Contractors and Consultants are CFA members – and for good reason.

- CFA members promote high standards, knowledge and expertise
- Specifying CFA members will maximize your investment and minimize costly flooring failures
- All members have to pass a vetting process



Image kindly supplied by Gerflor Ltd



Image kindly supplied by Junkers Ltd



Image kindly supplied by Interface

Tel: 0115 941 1126

آموزشگاه انعکاس منبع جدیدترین اطلاعات، مقالات و دوره‌های آموزشی دکوراسیون داخلی

Enekas.Academy

Enekas.Academy

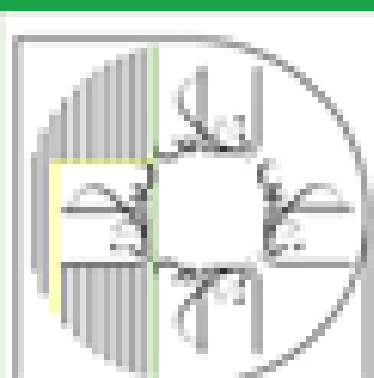



U.S. OLYMPIC AND PARALYMPIC MUSEUM OPENS TO PUBLIC

BUILDING FEATURES 20,000 SQUARE FEET OF GALLERIES, A STATE-OF-THE-ART THEATER, EVENT SPACE AND CAFÉ

The United States Olympic & Paralympic Museum has officially opened its doors to the public. The museum is a one-of-a-kind tribute to the Olympic and Paralympic movements, with Team USA athletes at the center of the story.

"This Museum has been nearly 10 years in the making, and we are excited that these incredible stories will come to life in Olympic City USA," said USOPM CEO Christopher Liedel. "The Museum is more than a sports museum. It is a museum of hopes and dreams. And we think the U.S. Olympic & Paralympic Museum will provide athletes and fans alike with a space to celebrate friendship, determination and all the best values Team USA athletes embody."



Photo: Jason O'Rear

آموزشگاه انعکاس منبع جدیدترین اطلاعات، مقالات و دوره‌های آموزشی دکوراسیون داخلی

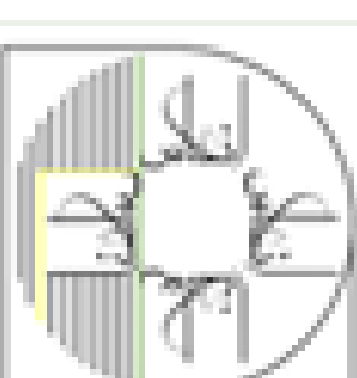
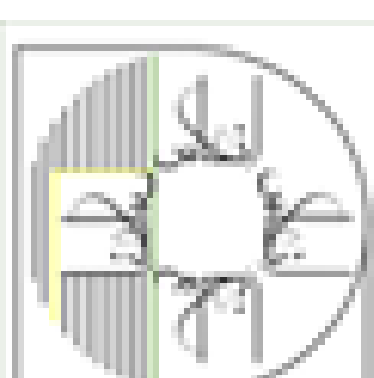

“

Every aspect of our design strategy has been motivated by the goal of expressing the extraordinary athleticism and progressive values of Team USA.

The 60,000-square foot building, designed by Diller Scofidio + Renfro features 20,000 square feet of galleries, a state-of-the-art theater, event space and café. Twelve galleries with exhibitions designed by Gallagher Associates follow a narrative arc that takes guests through Team USA athlete's journey. With its universal design and technology capabilities, the museum is one of the most accessible and interactive museums in the world. Guests can customize their sport preferences and accessibility needs for a tour that is uniquely their own. Team USA athletes were involved and consulted throughout the project to achieve the USOPM's goal of an authentic experience and inclusive design.

“Every aspect of our design strategy has been motivated by the goal of expressing the extraordinary athleticism and progressive values of Team USA,” said Benjamin Gilmartin, architect and Partner at Diller Scofidio + Renfro. “A taut aluminum façade flexes and twists over the building's dynamic pinwheel form, drawing inspiration from the energy and grace of Olympians and Paralympians. Inside, descending galleries are organized along a continuous spiral, enabling visitors of all abilities to have a shared, common experience along a universal pathway. After leading the museum's design for the past six years, I'm so moved by the collective, herculean effort that allowed us to now share these stories of perseverance with the public.”

Working alongside local and state health officials and its operating partner Gallagher Museum Services, the Museum has also taken extensive measures to provide a safe environment for guests and staff, including timed ticketing and various additional wellness procedures. More information can be found at usopm.org/safety.

To learn more, visit dsrny.com/project/us



Photos: Nic Lehoux



Photo: Jason O'Rear

آموزشگاه انعکاس منبع جدیدترین اطلاعات، مقالات و دوره‌های آموزشی دکوراسیون داخلی

Enekas.Academy

Enekas.Academy

ADDING VALUE BY UPGRADING YOUR HEATING SYSTEM

BY STEVE BIRCH, SALES DIRECTOR, VOGUE (UK)

We have found that there has been a distinct shift towards eco-conscious consumerism in premium bathrooms and I anticipate this trend is set to grow in 2021 as it becomes more mainstream. As more and more consumers discover the benefits of using materials, which are kinder to the planet as well as being more energy-efficient and cost-effective, I believe this type of bathroom design will continue to grow and develop at pace.



As we enter a period of growing economic uncertainty in terms of global recovery from Covid-19 and a process of re-adjustment following the three-phased plan for Brexit, UK consumers in general are likely to be conservative when it comes to purchasing new property, choosing to add value to existing assets which has shown new investment in the bathroom.

By virtue, heating is now viewed as a key way to upgrade the bathroom, with scope for both towel warmers and radiator to be more attractive and user-friendly all year round. As adding value becomes ever more important, we are seeing a move towards the use of aluminium as a must-have, covetable material for radiators in this key room. Aluminium, is regarded as one of the most sustainable materials in the world. As well as being an eco-friendly metal, it is renowned for its ability to conduct heat rapidly, which ensures end-users will save both time and money with this improved efficiency in low-water content products.

Another advantage of sourcing aluminium radiators is the opportunity for increased design flexibility and space planning, as these products can be easily installed on both stud and solid walls due to its lightweight core. This is extremely helpful when it comes to luxury residential developments where interior designers and architects are becoming ever more creative when working within the home, and also when working with discerning homeowners



who want to have maximum benefits combined with minimum disruption during a renovation or retrofit project.

Alongside the increasing demand for eco-homes in which materials are recycled and recyclable to minimise carbon footprints, the replacement market remains a strong part of the heating industry portfolio due to the age of the UK's housing stock, which is the oldest in Europe, and probably the world: according to a recent report from the BRE Group. The opportunities here for the heating professional are considerable, as offering eco-friendly heating solutions will provide your customers with a long-lasting, designer product.

In my experience, adding value to a home by upgrading your customers heating system is a sure investment, especially as more people are now working from home, which has led to a greater emphasis on sustainable living. A greener alternative to designs in brass and steel, we offer a blanket 30 years manufacturer guarantee across all aluminium models, which is much greater than the industry average typically between 5 to 15 years.

For further information, please contact Vogue (UK) for further information:

Vogue (UK) | t 01902 387 000 | e info@vogueuk.co.uk

www.vogueuk.co.uk

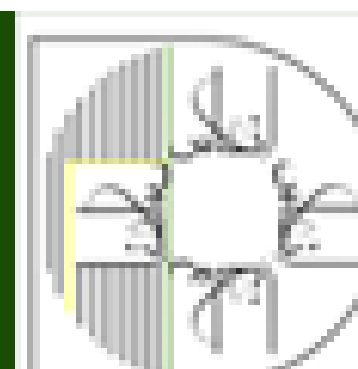

VOGUE UK

TOWEL WARMERS & RADIATORS

Vogue (UK) Ltd

Strawberry Lane, Willenhall, West Midlands, WV13 3RS. United Kingdom

T: +44(0) 1902 387000 F: +44(0) 1902 387001 E: sales@vogueuk.co.uk W: www.vogueuk.co.uk



آموزشگاه انعکاس منبع جدیدترین اطلاعات، مقالات و دوره‌های آموزشی دکوراسیون داخلی

 Enekas.Academy

 Enekas.Academy

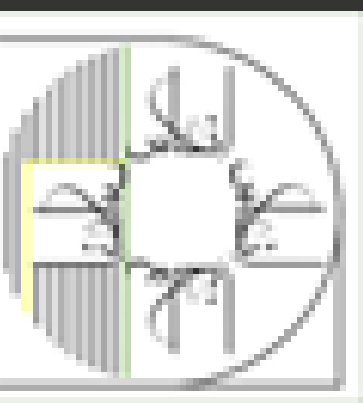
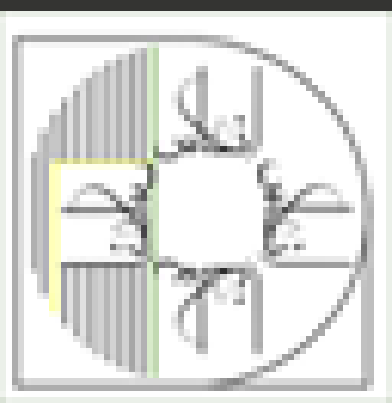

IMPROVEMENTS IN SAP* FROM USING THE HYBRID SYSTEM RESULTED IN LOWER PROJECT COSTS

Peter Dawson, Housebuilder



HYBRID INSULATION - TOGETHER FOR THE FUTURE



HCONTROL HYBRID



HYBRIS



BOOST[®] HYBRID

We know that making SAP improvements is high on your agenda. We also understand that minimal insulation thickness can help you to reduce overall project costs. So we have good news. The reduction in thermal bridging achieved by our Hybrid range is producing up to 15% SAP improvement*, proving that savings can be made on the DER vs TER without compromising on space.

All Hybrid products can be used in walls and roofs, separately or together, to provide a high performance, total insulation system. They are certified to harmonised standards by accredited bodies, are CE marked and have LABC and NHBC acceptance acceptance when used in accordance with the certification.

Each Hybrid product combines both insulation and airtightness properties:

- **HControl Hybrid**, a thin multifoil insulation product with a built-in vapour control function and an unrivalled thermal performance.
- **Hybris**, an innovative reflective insulation product providing an excellent thermal performance.
- **Boost[®] Hybrid**, a thin multifoil insulation product with a built-in breather membrane function and an exceptional thermal performance.

*as calculated over a standard house using Hybrid model junctions compared with default junction heat losses

To find out more visit www.insulation-actis.com or call 01249 462888



ACTIS

TOMORROW'S INSULATION TODAY

آموزشگاه انعکاس منبع جدیدترین اطلاعات، مقالات و دوره‌های آموزشی دکوراسیون داخلی

Enekas.Academy

Enekas.Academy

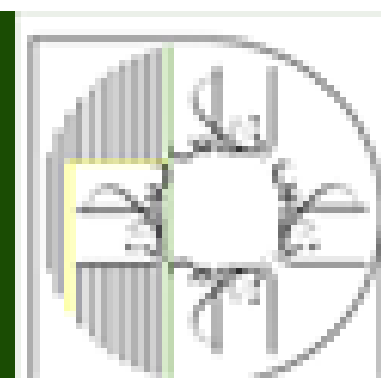
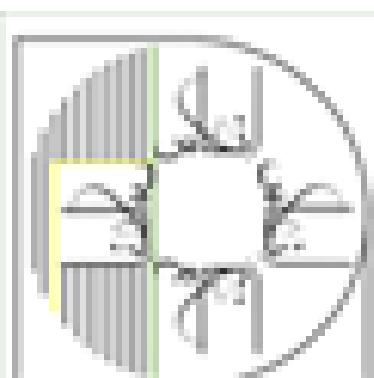

J & P BALCON®

INSULATED STEEL BALCONY CONNECTION SYSTEM

Easy Balcony Positioning Tolerance.

Excellent Load Capacity.

Thermal Insulation Performance to Meet Part L.

- Designed for your specific balcony to concrete connection
- Cost-effective, high quality components
- Excellent thermal insulating properties
- Easy to set into position with no need to cut edge shutter
- High load performance with fast installation
- Very low deflection at the connection to the structure
- An approved LABC Registered Detail
- Quality management to BS EN 1090-1 and ISO 9001:215



Need a high-quality and cost-effective insulation system for your current project?

Contact us today to learn more, or visit our website at www.jp-uk.com

J&P Building Systems Limited
Thame Forty, Jane Morbey Road,
Thame, Oxfordshire OX9 3RR

01844 215 200
www.jp-uk.com
enquiries@jp-uk.com

J&P Building Systems Ltd. is a subsidiary of:



آموزشگاه انعکاس منبع جدیدترین اطلاعات، مقالات و دوره‌های آموزشی دکوراسیون داخلی

Enekas.Academy

Enekas.Academy

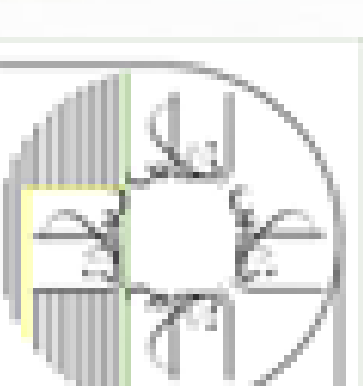
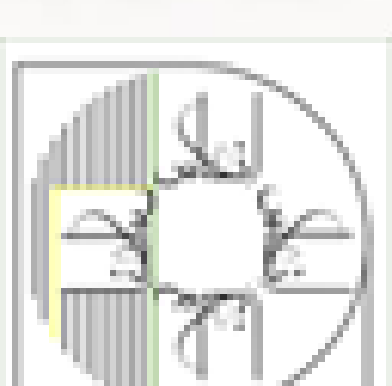

All your heating needs 100% FREE*

PCM
Phase Change Material

*Use with solar vacuum tubes or photovoltaic powered ground and air source pump systems

ALL YOUR HEATING & COOLING NEEDS 100% FREE

By introducing eutectic products into a radiant heating system, it is possible to capture excess heating during daytime using conventional solar collectors such as vacuum collectors or PV Thermal collectors and store the free solar energy within the floor Phase Change Material thermal energy storage (PCM-TES). In return over-night, this stored energy acts as a radiant heating floor and keep the occupied space warm. As the heating can be provided without using any primary energy source, it offers an unparalleled environmentally friendly and cost-effective solution for both domestic and commercial heating applications. Furthermore, as PCM-TES has no moving parts it also offers a maintenance-free heating system.

ThinICE CONCEPT

By simply adding 27°C (81°F) ~ 34°C (93°F) phase change material (PCM) encapsulated in sealed HDPE modules, one can increase the heat storage capacity of the floor screed by 50-fold.

As this material captures energy by melting and releasing it when it freezes using solar free energy it offers a cost-effective and environmentally friendly heating option. If required a small scale heat pump can be incorporated not only to top up this heating but also provide the hot water requirements and even the possibility of running this small heat pump from solar PV cells and maybe during off-peak hours one can provide a reliable and very low running cost system with a very attractive return on investment.

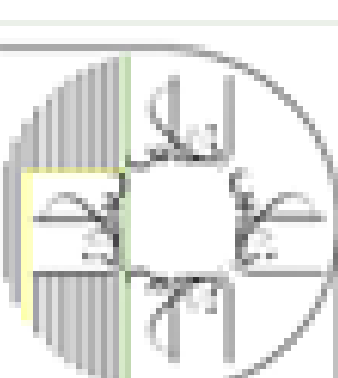
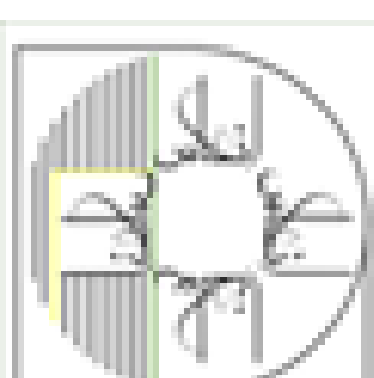

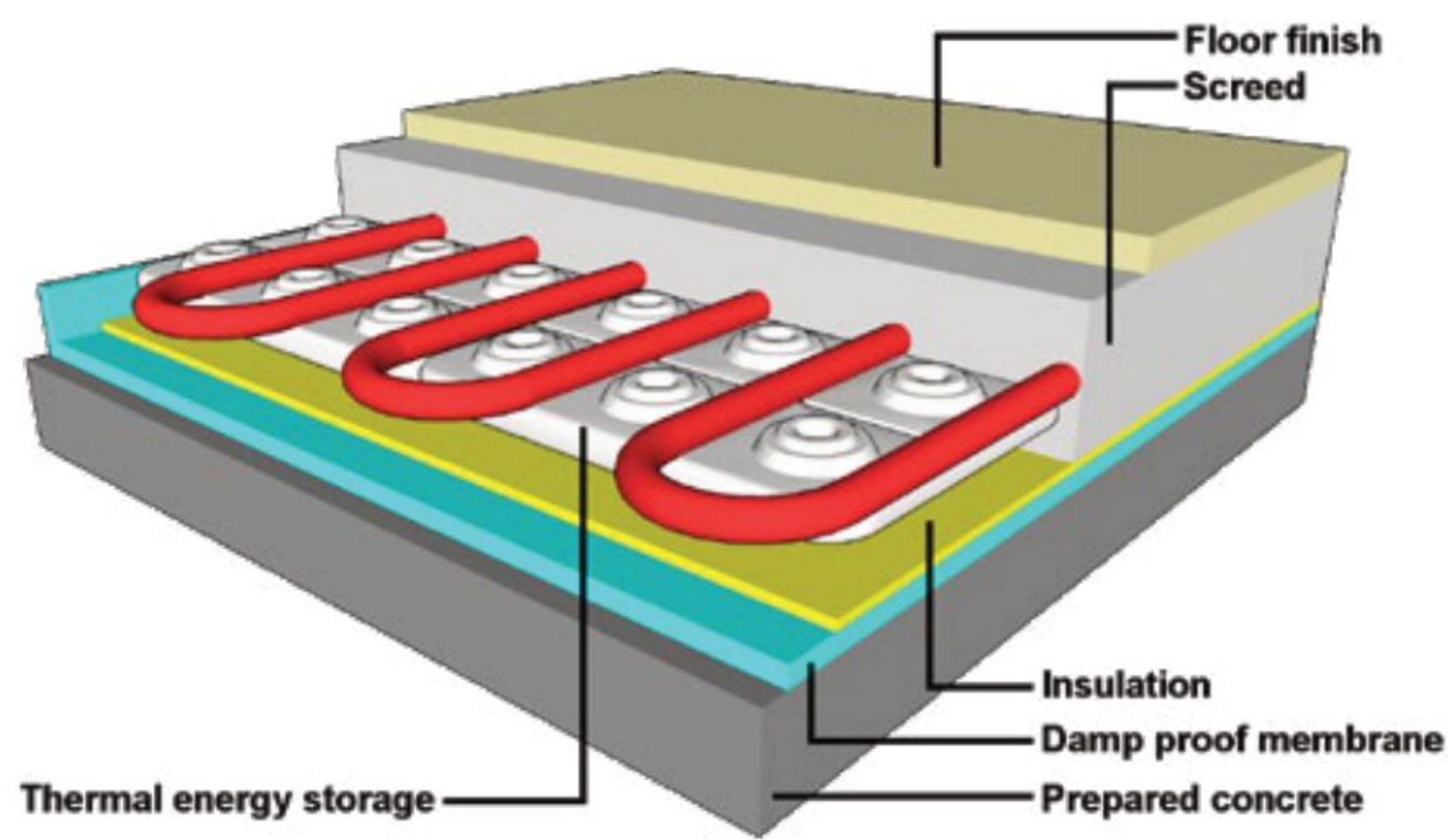
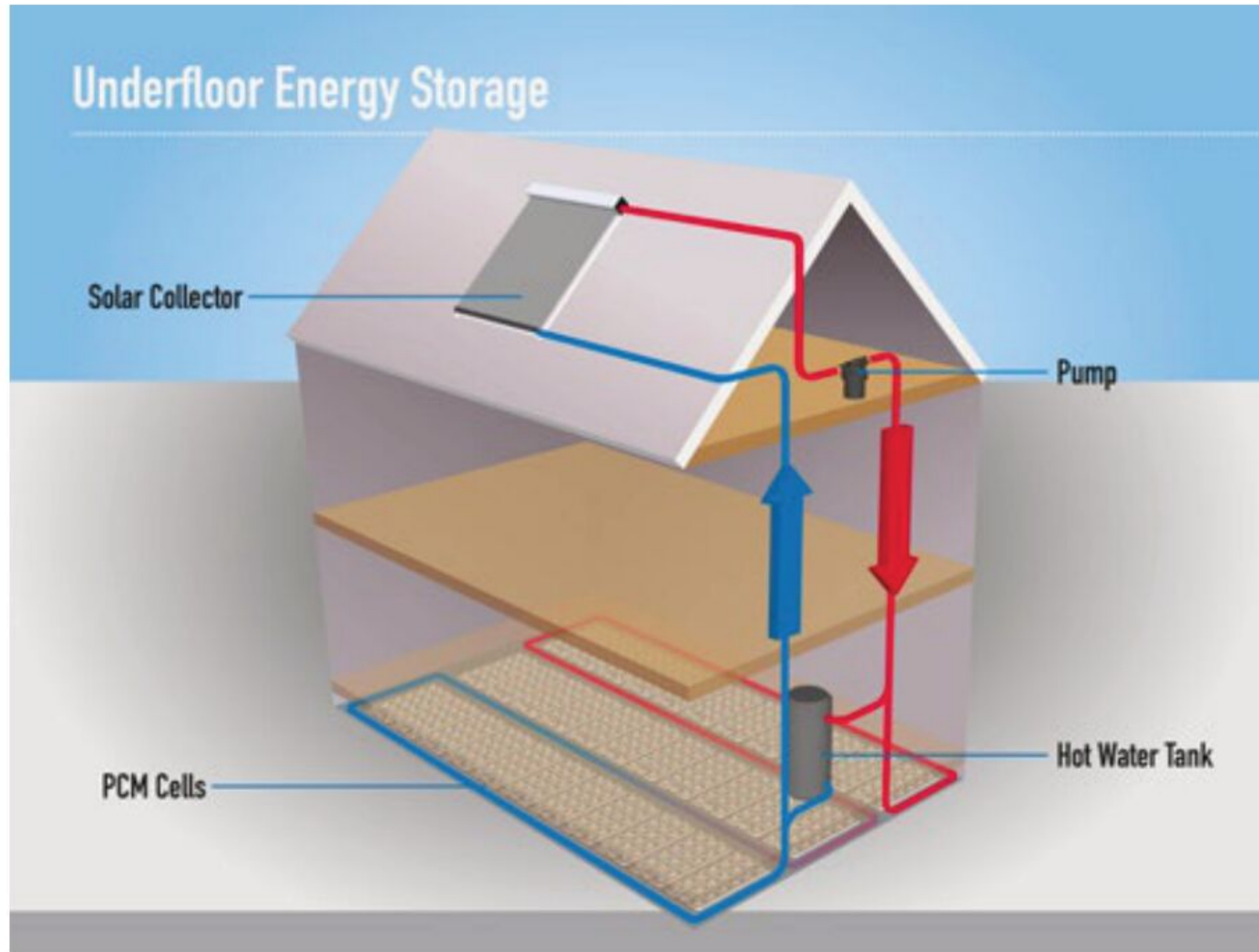

PASSIVE COOLING

It is also possible to use ThinICE modules for free cooling by simply placing them within the ceiling area where the over-night cooler space conditions freeze the PCM and in return during day heat gains can be absorbed by the PCM like a heat sponge. As long as the sponge i.e. PCM panels are big enough to soak up the daily heat gains the occupied spaces will remain cooler in comparison without any thermal storage facility. This passive cooling concept could be either static, passive or can be complemented with cooling pipes as in the case of the chilled ceiling concept.

Thanks to there being no moving parts, PCM TES is effectively maintenance free and once installed it simply becomes part of the building.

Again, as there are no moving parts, PCM-TES passive cooling concept offers very attractive low running cost and as the concept utilising free energy it offers very attractive environmentally friendly cooling options for many domestic and commercial applications.

Each module features several grooves which are optimally spaced out for runs of underfloor heat pipes. This close contact with the PCM ensures the best heat transfer possible. They allow for pipe lengths to be easily held in place during the installation process requiring no specialist skills.

www.pcmproducts.net

INSTALLATION

At normal conditions the PCM will be in solid form, making the modules very robust. Rows of modules can be laid directly on top of the insulation layer replacing conventional castellated panels. This creates a grid that allows the heating pipe to be laid easily, holding the heat pipe in place throughout the screening process to ensure that the finished underfloor heating system will distribute heat evenly.

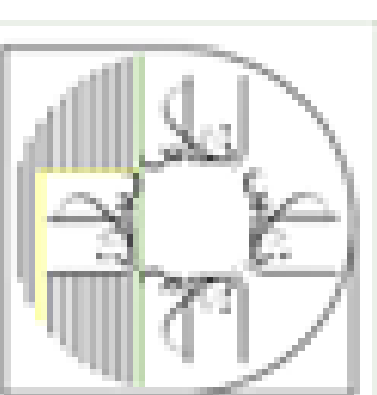
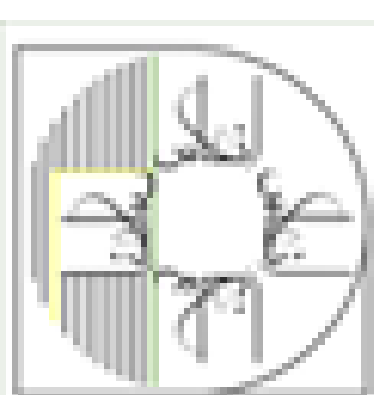
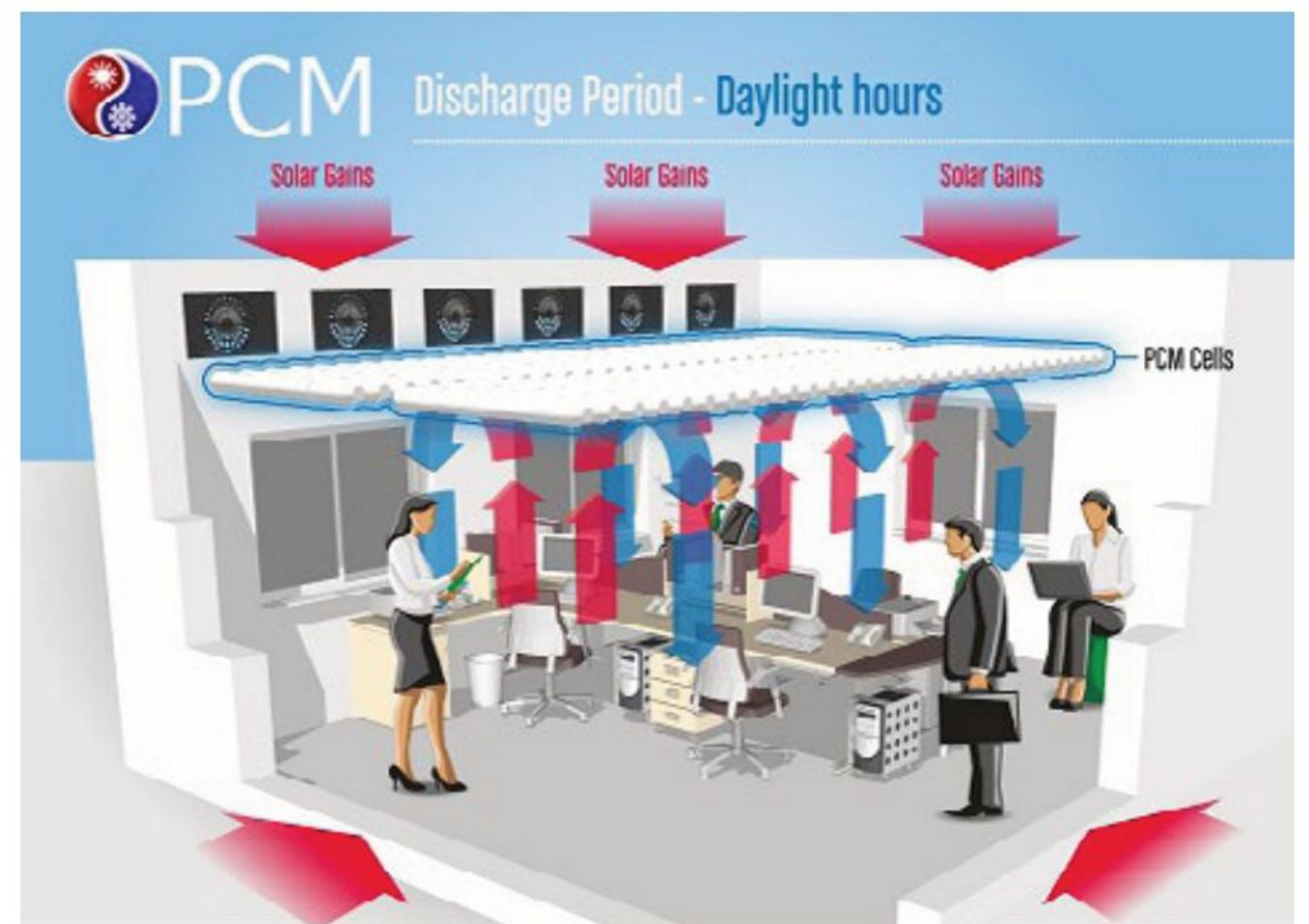

UNDERFLOOR HEATING TICKS ALL THE BOXES!

By Steven Rooney, Sales Director at Gaia Underfloor Heating

When it comes to heating, there is no single off-the-peg solution that suits every situation and it is no longer a case of considering the individual components in isolation. Now the emphasis is on looking at the whole project design and mixing and matching various systems to achieve the most appropriate overall solution.

This is being driven by the building regulations which, in turn, are taking account of the sustainability agenda, energy use and reduction of CO2 emissions in buildings. As a consequence, suppliers that provide total designed solutions rather than individual products are in a winning position.

Underfloor heating (UFH) - whether wet or electric - is well placed to be part of a holistic design solution. It scores well in terms of environmental performance and is regarded as economical, ultra-efficient and comfortable.

Simple to install and control, UFH wastes no heat at ceiling level and frees up valuable wall space, providing complete design freedom. Wet systems circulate water at low temperatures through a series of continuous pipe loops laid within a screed, or between timber joists, beneath the floor surface. Electric systems consist either of cables laid within the screed or cable mats laid on top of existing subfloors.

Importantly, UFH has the ability to tick the boxes when it comes to working with renewable energy and sustainable solutions yet it cannot do this in isolation. It must be considered in terms of the other components that make up the floor such as insulation, screed and floor coverings as well as in relation to the energy source, the overall specification of the building and level of sustainability being sought.



In this market, it is increasingly important for companies to deliver a one-stop-shop, solution-driven service that 'bolts' together multiple products to deliver true value to the client. And value, in these terms, represents more than price and product; it is about customer service and certainty with one point of contact, bespoke design, shortening of the build programme, ease of installation, compliance with regulations and end-user appeal, plus a warranty based on the knowledge that the company is well established and is still likely to be in existence in ten years time.

For further information contact Gaia, call 01359 242 400 email info@gaia.co.uk or visit www.gaia.co.uk.

Beautiful Designer Ceiling Fans

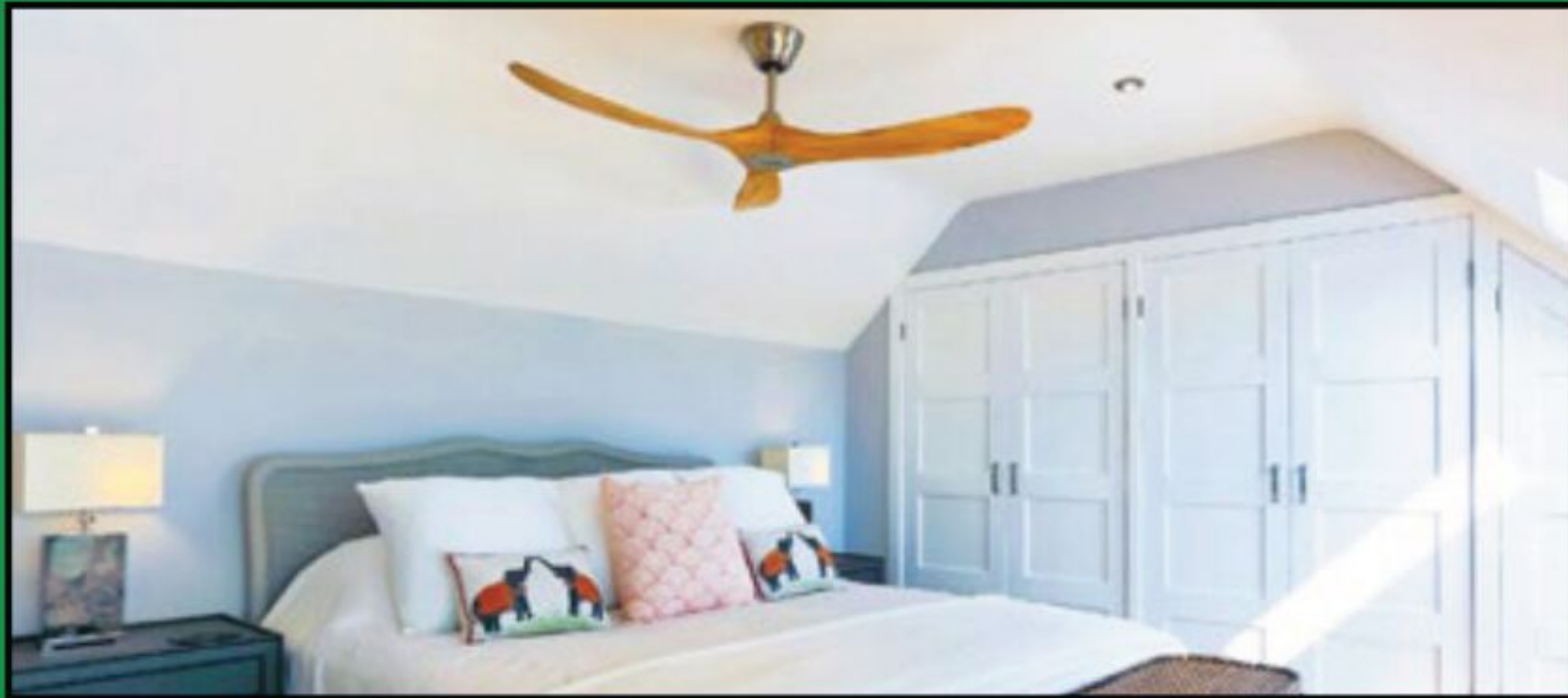

Powerful - Stylish - Reliable - Silent



THE HENLEY FAN COMPANY LTD



01256 636 509
www.henleyfan.com



NEOMITIS

Creating innovative solutions for ambient comfort



Finally enjoy control without effort!



Also available in white

SOON
Wireless version

myneo Fluid Curved

myneo Stat

A concentration of technologies designed for your comfort and to decrease your energy consumption while making your life easier.



www.neomitis.com



4th Floor, Lincoln House, 300 High Holborn, London WC1V 7JH, UNITED KINGDOM
Tel: +44 (0) 2071 250 236 - Fax: +44 (0) 2071 250 267 - E-mail: contactuk@neomitis.com

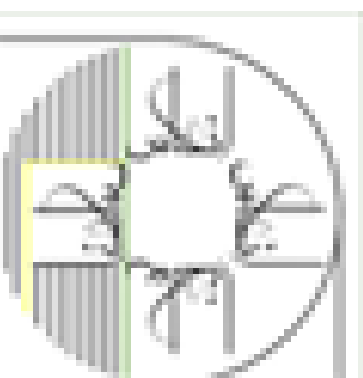
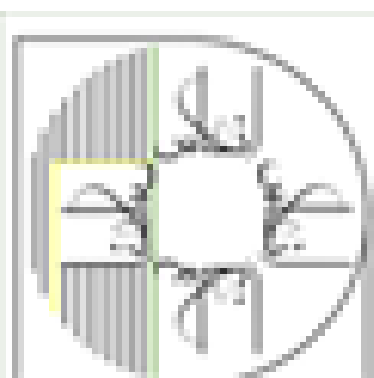



NO. 9 RHAPSODY

THE NATURE OF DESIGN IS TO MAKE SOMETHING OUT OF NOTHING

The studio space of a designer is the source of thoughts and concepts and a site of imagination. Therefore 9Studio Design Group designed their own studio like the setting for a science fiction movie with a strong sense of prop. The inexhaustible imagination lays out the spatial need.

VARIATIONS AND EXPANSION IN SPACE

The two units yield multiple compositions and expansions in response to distant characters. The cubic unit is applied on the couch, blanket, and steps, where the cubes cover the multi-dimensions of up and down, left and right. The stereometric layering defines the openness of multiple compositions on the first floor, such as the movable layout of the furniture, the salon area for a small lecture, and the gathering. The transparent door with a steel frame connects the inside to outside, implying the interlocking relationship between the two.

The black steel panels form the curvaceous unit and the layering of geometric shapes are distorted and divided like an organic morphology of water bar, information desk, and the long dining table. The working desk on the second floor combines wood joints with steel panels. The structure looks like a butterfly that appears light and heavy at the same time. The symmetric shape facilitates the smooth circulation of the workflow.

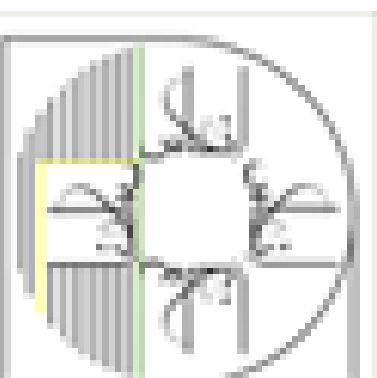
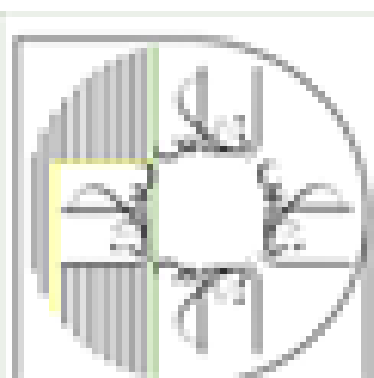
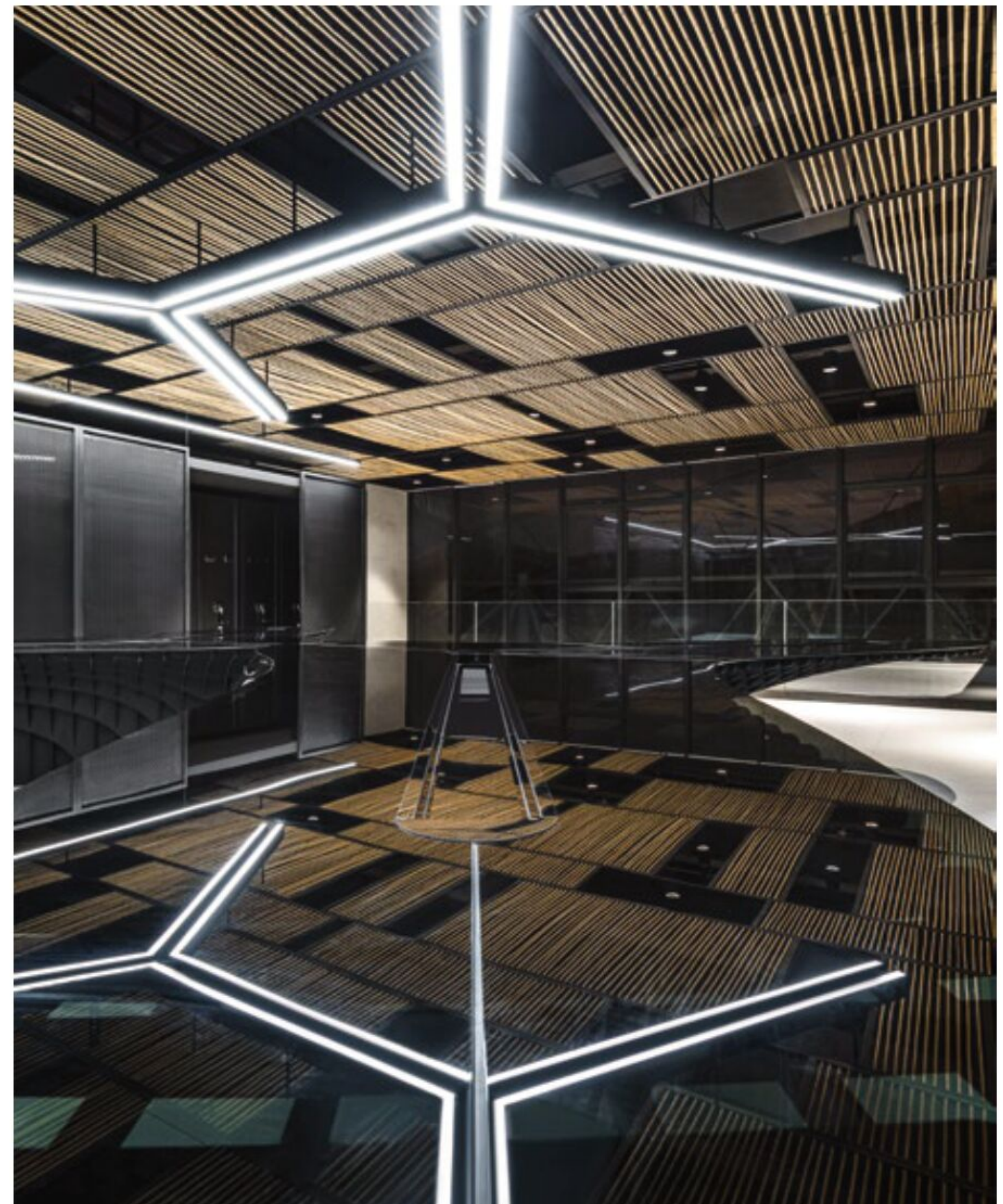

“

The two units yield multiple compositions and expansions in response to distant characters.



DEFINING THE WORK SPACE

1) The first floor is the lounge. The second floor is the working area. The long table on the center facilitates the discussion. The supporting functions are laid out on the periphery, such as the LED screen, cabinet, printing room, material display room, and library. There is no director's office. Each employee is free to walk and exchange ideas with their own choice of the work area.

2) Work as life: The sense of relaxation is enhanced by the pond, greenery outdoor, the kitchen, and dining table indoor with bamboo panels on the ceiling.



THE PURITY OF MATERIAL

The use of simple elements such as wood, steel, and artistic paints achieve the purity of the space in this project. It also expresses the central mission of the company: to form the attitude and purity of design through the nature of the material.

Project Name: No. 9 Rhapsody

Client: 9Studio Design Group

Designers: Tung Tsan Lee

Budget: 1.9 million RMB

Completion date: 2019.10

Area: 330m²

Material: black iron, black glass, metal mesh, special paint, natural bamboo, wood & biofiber plastic composites, quartz brick

www.archello.com/brand/9studio-design-group

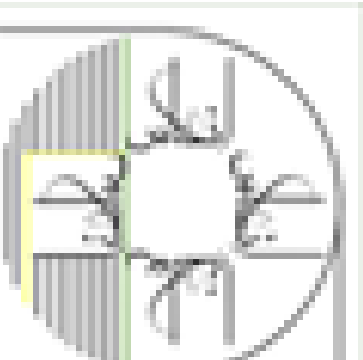
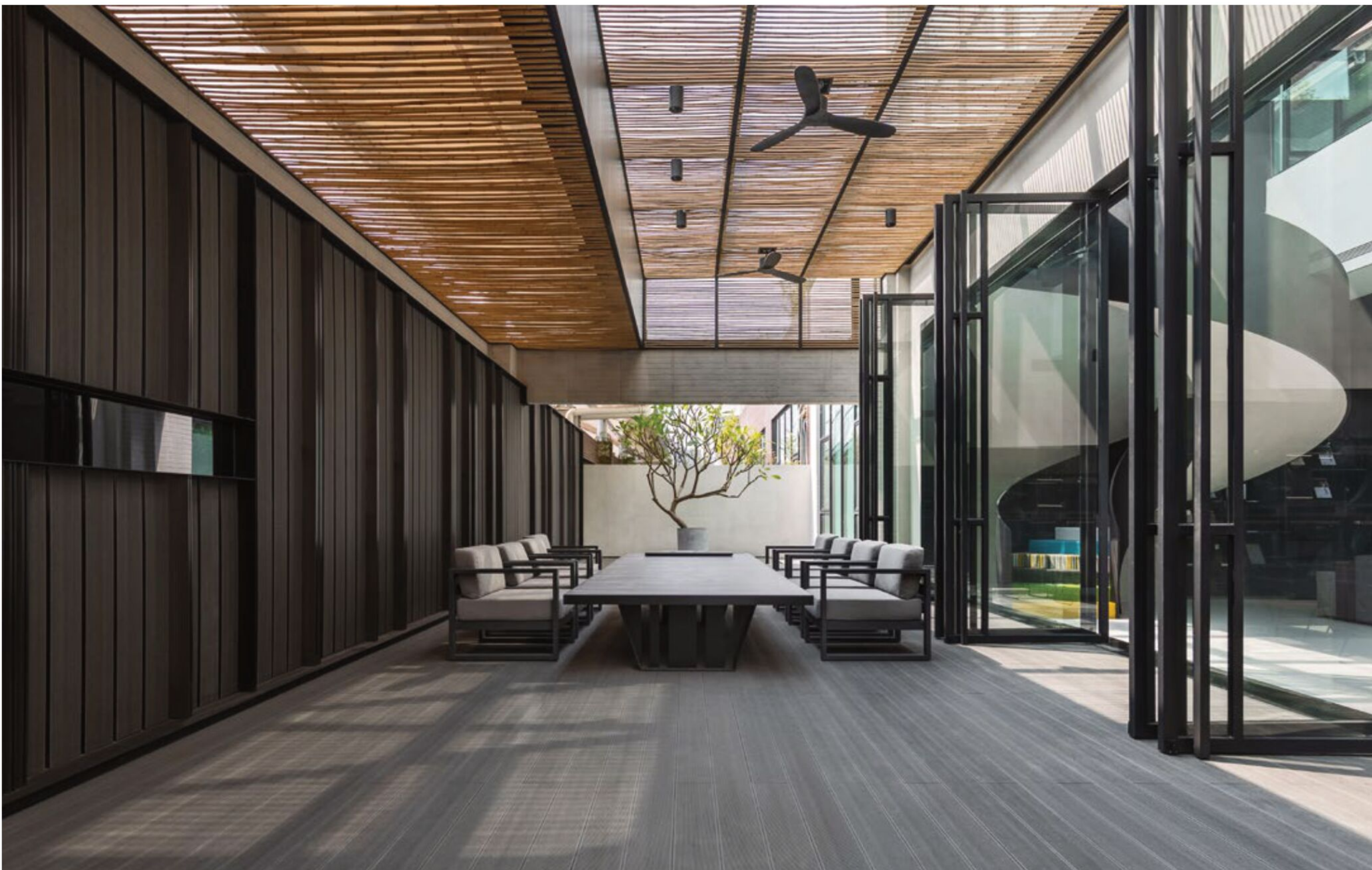



GIVING YOUR HOME THE EDGE

It was another triumph for the Cheshire-based SONA team as they took home a staggering six CEDIA awards this October. SONA, who specialise in luxury home technology and run by husband and wife team Simon and Nicola Fulstow, were crowned winners in multiple categories for their 'The I's Have It' integrated home project.

Managing Director Nicola Fulstow says: "To win six awards is something that makes us immensely proud." The project took home the accolades for Integrated Home Level III, Best Dressed Rack, Best Documentation, Best Lighting, Life Lived Best at Home and Best Integrated Home (Global).

Nicola adds: "It's still sinking in. From Simon being a one-man band 8 years ago to now being Global Winners for the Best Integrated Home. It's still sinking in. Certainly, a much welcome lift for our team who have worked relentlessly, despite the challenges that 2020 has brought the world."

SONA worked side by side with the client, who contributed many of his own ideas. Simon Fulstow, the Founder and Technical Design Director says: "Having worked with this client on his former home, we already had an established relationship and that trust meant we had a lot of fun bringing together his ideas and our expertise to create this remarkable home."

In particular, the SONA team is extremely proud to have earned the Life Lived Best at Home Award. Simon adds: "This award honours the project that best uses technology to maximise and enhance the client's lifestyle. We don't see ourselves as a technology company – we view our role as creating the optimal environment for the homeowner to thrive in.

"That's why we always start at the end. We envisage the client living in the home. We get to know in depth how they want to feel when they are relaxing, entertaining, reinvigorating at home. Then we take those feelings and create a situation that allows that to happen in the space."

The project featured an integrated 250-circuit lighting system, motorised window treatments, floor to ceiling glazing, a high performance AV system, two media spaces, intuitive controls and one of the only artificial skylights in the country.

At the time of writing, SONA is one of only 15 CEDIA 'Members of Excellence' worldwide, a coveted status that honours only the best in the field of luxury home technology. "We're so proud of how far we've come," says Nicola. "The only way is up."

www.sona.technology

SONA
LUXURY | TECHNOLOGY

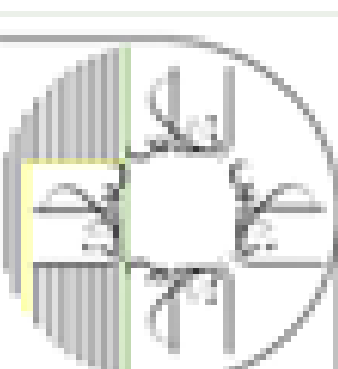
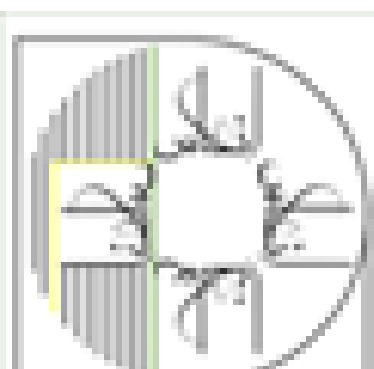



SONA
LUXURY | TECHNOLOGY

AWARD WINNING INTEGRATED HOMES

SONA create subtle, effortless and beautiful home technology systems that give your home the true feeling of luxury.

HOME CINEMA / LIGHTING / AUDIO VIDEO /
SECURITY / NETWORKING / WELLNESS

/ 01625 54 14 42
/ INFO@SONA.TECHNOLOGY
/ WWW.SONA.TECHNOLOGY

    @THINKSONA

آموزشگاه انعکاس منبع جدیدترین اطلاعات، مقالات و دوره‌های آموزشی دکوراسیون داخلی

 Enekas.Academy

 Enekas.Academy

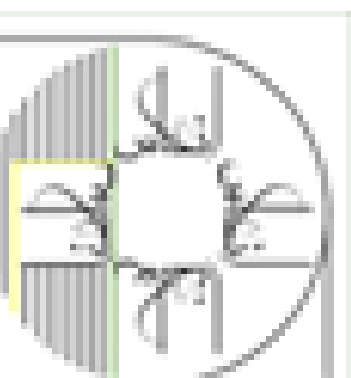
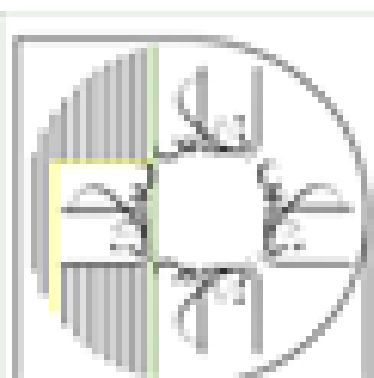

STUNNING NEW PROJECTS WITH ELEGANT ACOUSTIC DESIGN

Danish manufactured Troldekt panels are commonly specified throughout the UK and Europe to improve the interior acoustic environment. Two recent Danish projects are the transformation of an old building into a car dealer's offices for Karvil Biler, while the other is an extension of Randers Architects' own headquarters into a mix of offices and exclusive residential units.



create a coherent look. The milled grooves have a visually calming effect and contrast well with the new raw concrete floor," the project manager explained.

Troldekt® line forms nine acoustic solutions that make up the "design solutions" range which combines the best ideals of form and function.

Founded on the Cradle to Cradle

Both projects use Troldekt® line with its perfectly symmetrical vertical lines to balance walls and ceilings with great aesthetics, conveying warmth and providing a modern look coupled with high performance sound absorption.

design concept, 100% Troldekt's natural wood wool panels are manufactured in a new state-of-the-art production facility. With a variety of different surfaces and colours, they can be supplied in the FSC® 100% category (FSC®C115450) contributing to a building's BREEAM, DGNB and LEED rating.

For the Architects' washrooms, Troldekt® line was chosen to add visual vibrancy to the rooms. It also exhibits different appearances depending on the angle from which the wall surfaces are viewed. The edges have been milled where the panels meet the ceiling, around electrical sockets and switches and also at floor level where bamboo skirting has been integrated. All have been elegantly cut to ensure a neat finish and fine detailing.

In addition to their high sound absorption and tactile surface, the panels offer high durability and low cost life cycle performance, as well as inherent sustainability. They are also a natural, breathable material which can absorb and release moisture, which is why they have been awarded an Allergy Friendly Product Award by Allergy UK.

In the car dealers, Troldekt® line was selected in order to enhance and benefit the whole indoor climate. "We wanted to

Samples, case studies and technical information are easily sourced from tel 01978 664255 or visit www.troldekt.co.uk

TAKING THE RIGHT STEPS TO COMBAT FIRE

Premier Loft ladders' growing range of fire rated loft ladders offer the benefits of increased warmth retention and safe access, whilst providing up to 120 minutes of fire protection.

Over the past couple of years, Premier Loft Ladders has introduced several new loft ladders to its product range. A great example of these are the innovative Klimatec 160 Passivhaus, Isotec and Isotec 200 (pictured) loft ladders. All feature high strength steel ladders and offer superb thermal insulation. Also, they all benefit from fire-resistant hatch boxes (the Isotec offering up to 120 minutes protection). Furthermore, the Klimatec 160 is certified for use in passive buildings.

These new products accompany the already well-established fire-rated products on offer from Premier Loft Ladders, including the popular Supreme loft ladder range, as well as the compact MiniLine. These concertina loft ladders feature high strength components and counter-balanced operation, making access to loft space, plant rooms or a flat roof terrace safe and easy.

Furthermore, Premier Loft Ladders have recently released a new range of BIM models. These make it even easier for architects and designers to specify the perfect fire-rated loft ladder their project. The BIM objects are available in both Revit and IFC format.



**Visit Premier Loft Ladders web site to explore their full range of fire rated loft ladders www.premierloftladders.co.uk/product-range/fire-resistant-loft-ladders/
T. 0345 9000 195
E. sales@premierloftladders.co.uk**

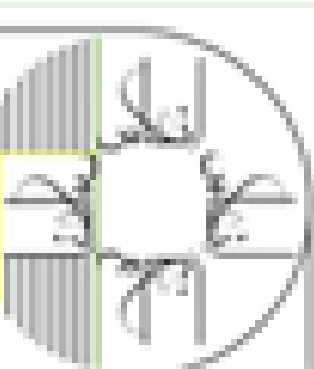

LALIQUE

&

PIERRE-YVES ROCHON



SIGNATURE

lalique.com

Lalique Boutique - 47 Conduit Street - London W1S 2YP
0207 292 04 44 - shop.london.cs@lalique.fr

آموزشگاه انعکاس منبع جدیدترین اطلاعات، مقالات و دوره‌های آموزشی دکوراسیون داخلی

 Enekas.Academy

 Enekas.Academy

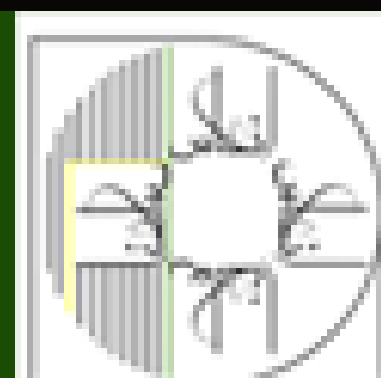
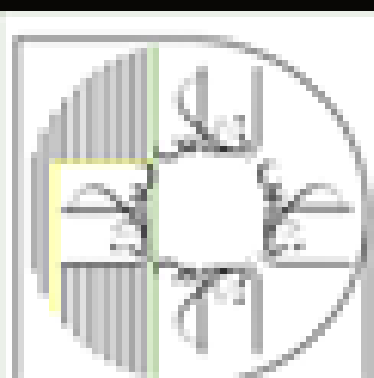



INNOVATIONS IN ACCESS PANELS

If you expect your Access Panels and Hatches to have unrivalled innovative product features and the latest product designs, check out Ceildoor Products Limited.

Based in the West Midlands, Ceildoor design and manufacture their range of Access Panels on-site, offering next day delivery on standard sized panels. The company has worked in the industry for nearly 30 years and are continually researching methods to enhance product features and launch new designs.

Unique feature innovations include Cap-less™ and Unihatch®.

Customers are loving Cap-less™ - a new innovation in how Access Panel lock holes are covered – which are only available with Ceildoor Access Panels and at no extra cost to customers!

Launched recently, Cap-less™ is a metal lock hole cover which is integrated into the Access Panel and solves the problem of missing plastic caps which fall off and need replacing. Now there are no more unsightly holes in Access Panels due to the caps being lost.

The Cap-less™ cover simply slides back to expose the lock and automatically closes on release to cover the hole. Unlike plastic caps, Cap-less™ is available in a full range of RAL colours to blend in perfectly with the required access panel paint finish.

Made from the same zinc plated mild steel as the access panel and fitted as standard at no extra cost to most of their metal faced range, Cap-less™ has become a firm favourite with customers old and new.

Another unique feature is the Unihatch® which enables the door face to be easily reversed within the same frame - without removing the frame from the wall or ceiling.

For example, if you buy a plaster faced version, you can reverse the door in-situ and turn it into a metal faced door version quickly and in a few easy moves.

What's more, you can also change the hinge orientation every 90 degrees on a square panel or 180 degrees on a rectangle panel,

“

Cap-less™ is a metal lock hole cover which is integrated into the Access Panel and solves the problem of missing plastic caps which fall off and need replacing.

without having to remove the frame from its finished location in the wall or ceiling.

But it's not only product features that Ceildoor invent. Their Air-tight, Circular and Acoustic Access Panels are designed with unique features to address specific industry needs.

Ceildoor's Air-Tight Access Panel has undergone extensive third party testing and its silver ion anti-bacterial coating is proven to actively reduce bacterial growth without being harmful to humans. The panel is fitted with a high-density gasket sealing system which creates a highly protective barrier once closed and is ideal in healthcare environments, operating theatres, clean rooms etc.

For those who want an alternative to square Access Panels, the Circular Access Panel is designed for bespoke interiors and is fitted with the unique UniTwist™ mechanism.

In areas that require sound containment, the Acoustic Access Panel reduces airborne sound from passing through access points. This feature has been independently tested under strict conditions.

For unique product innovation and unrivalled features, choose Access Panels from Ceildoor Products.

www.ceildoorproducts.co.uk

Ceildoor 
The Access Panel People

THE LATEST INNOVATION IN ACCESS PANEL DESIGN FROM...

Ceildoor®

The Access Panel People

Unique. Unrivalled. Unsurpassed. It has to be Unihatch®

unihatch®

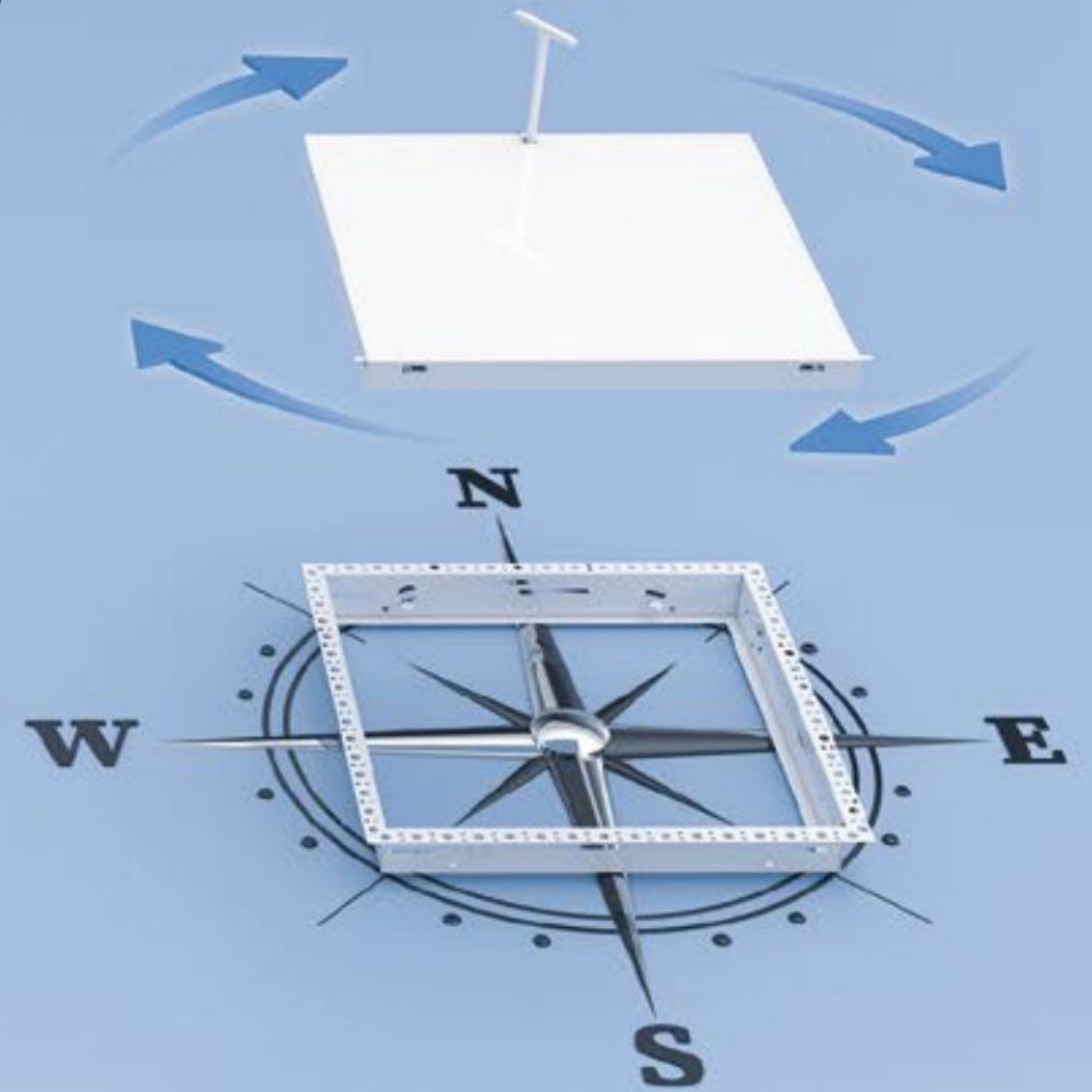
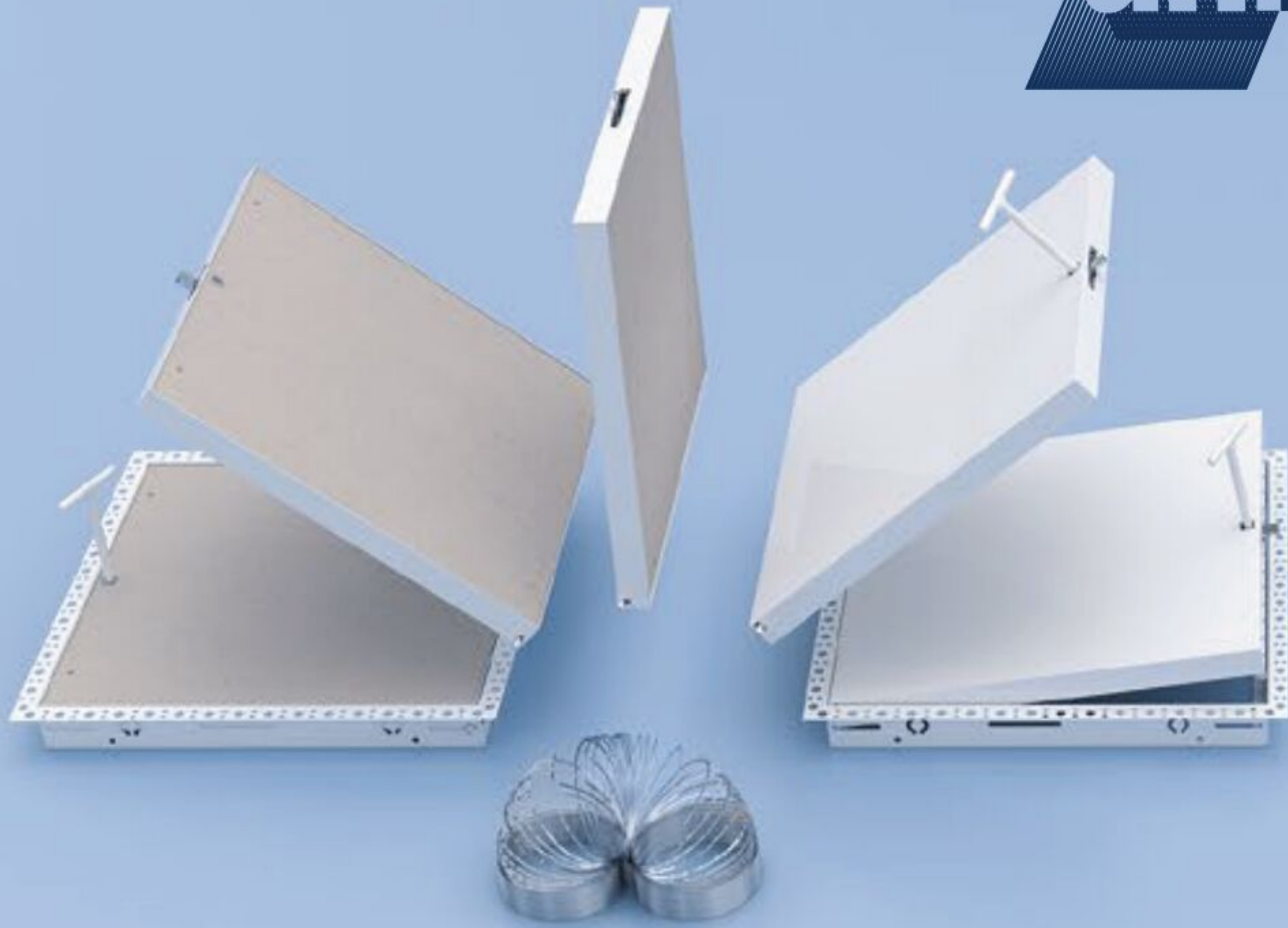

Reversible Door



Any Orientation

Unihatch® is a registered trade mark of Ceildoor Products Ltd Patent GB2456646

Cap-less™

Capless For Life



Say good-bye to missing plastic caps...

...with Ceildoor's UNIQUE square metal lock cover

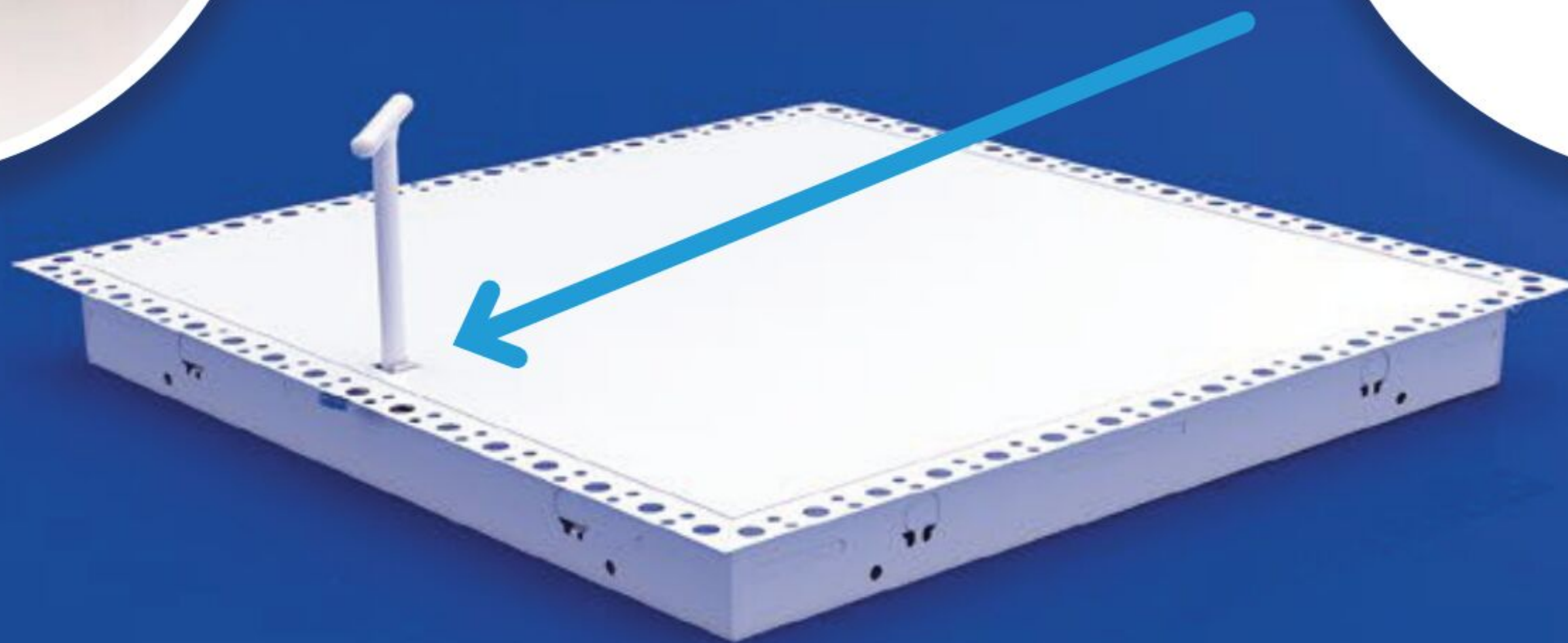

Cap-less is a trade mark of Ceildoor Products Ltd Patent GB2580742A

Tel: 01902 733645

www.ceildoorproducts.co.uk

آموزشگاه انعکاس منبع جدیدترین اطلاعات، مقالات و دوره‌های آموزشی دکوراسیون داخلی

Enekas.Academy

Enekas.Academy



BRITISH LAND'S STOREY OFFICIALLY OPENS 6 ORSMAN ROAD

FLEXIBLE PRIVATE WORKSPACE IN THE HEART OF HAGGERSTON

Storey has officially opened its doors to 6 Orsman Road, its latest building located on the banks of Regent's Canal in the creative hub of Haggerston. The sustainably focused office building comprises 34,000 sq. ft. across five floors and has been designed to enhance productivity.

Storey is British Land's solution to flexible private workspace; flexible in terms of lease length, size of office, layout and design, and a suite of all-inclusive services. This nimble approach allows customers to create an office that is truly designed and built around their company's needs. 6 Orsman Road has been designed to cater for businesses with 20+ employees and customers will

benefit from Storey's focus on private space and the 'Storey spine system', which offers a unique sustainable and re-configurable office model, enabling workspaces to easily adapt to changing office requirements.

CHAMPIONING SUSTAINABLE MATERIALS

Designed by locally based and leading architectural practice Waugh Thistleton Architects, Storey's 6 Orsman Road is championing the use of sustainable materials for flexible offices. The building's design is aligned to the core principles of sustainability and throughout the design process there has been a focus on reducing environmental impact by reusing or recycling materials where possible.

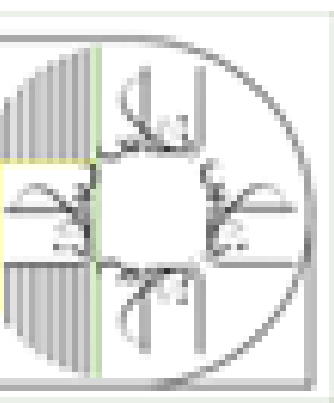

“

Everything at 6 Orsman Road, from the exposed timber to the waterside setting, has been designed to make customers feel calm, focused and inspired.



At 6 Orsman Road a cross-laminated timber (CLT) structure has been used to reduce the building's impact on the environment, as compared to concrete and steel CLT production requires less water and energy to manufacture. CLT is also exposed internally at 6 Orsman Road, minimising the number of finishes used on the structure, and the offcuts from the building have been repurposed to make furniture within the shared spaces of the building.

To further enhance the sustainability of the building, 6 Orsman Road has photovoltaic cells on the roof which are a renewable energy source. The expansive rooftop terrace has been designed by landscaper FFLO and is bio-diverse, featuring a brown roof, insect boxes, edible plants and fruit trees.

DESIGNED TO ENHANCE PRODUCTIVITY AND WELLBEING

Everything at 6 Orsman Road, from the exposed timber to the waterside setting, has been designed to make customers feel calm, focused and inspired. Storey worked with leading acousticians Sandy Brown to develop acoustics guidelines for the office to ensure that there were a range of spaces where productivity would not be impacted by bustle and noise; the timber surfaces and panels within the building have a special acoustic benefit, absorbing sound and so improving comfort.

Other areas within the building have been created for noisier and more collaborative work, such as the lounge and the café, ensuring activities at different noise levels happen in different spaces.

Throughout 6 Orsman Road a range of all-natural materials have been used, including clay finishes and marmoleum tiles, which when paired with natural daylight and air-purifying plants come together to create a working environment that actively boosts productivity and improves wellbeing. Studies by the World Health Organisation have found that the use of biophilic design can increase office productivity by 8% and wellbeing by 13%, and companies with timber interiors report higher staff retention, and fewer employee sick days.

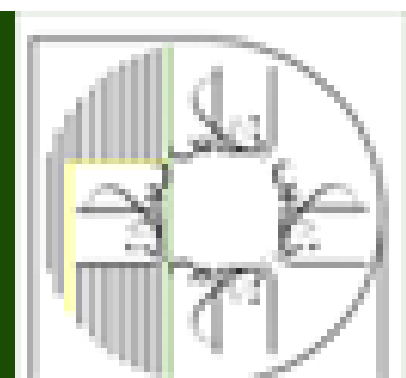



Tranquil, canal side location in London's latest creative hub 6 Orsman Road is located in a prime position on the bank of the tranquil Regent's Canal in Haggerston, between Shoreditch, Hoxton and Dalston. Haggerston benefits from fantastic cycling routes across London and is conveniently located on Super Cycle Highway 1. From here customers of 6 Orsman Road can cycle to and from work with ease, reaching Shoreditch in 6 minutes, Broadgate in 8 minutes and Liverpool Street in 10 minutes.

Customers at 6 Orsman Road will also benefit from the thriving creative scene in Haggerston, which is home to a wealth of independent eateries, coffee shops and boutique stores, as well as art, music and design studios, including Alexa Chung, Roksanda and Resident Advisor.

Panoramic views across London with onsite amenities
Customers of 6 Orsman Road will be able to enjoy a range of onsite amenities, including private and shared rooftop terraces with panoramic views over London. The spacious terraces have been specifically designed to allow multiple working styles through the use of outdoor shading, providing a range of spaces to suit everyone's needs.

“ Customers at 6 Orsman Road will also benefit from the thriving creative scene in Haggerston, which is home to a wealth of independent eateries, coffee shops and boutique stores, as well as art, music and design studios, including Alexa Chung, Roksanda and Resident Advisor. ”

Additional amenities will include generous cycling and shower facilities complete with fresh towels. Storey have also partnered with the Shoreditch Trust's social enterprise training Restaurant Waterhouse, who will run the café on the ground floor. The café will serve a range of local and ethically sourced healthy food.

For more information or to book a tour of 6 Orsman Road, please contact the Storey sales team on 020 7467 3451 or workspace@storey.co.uk or visit their website www.storey.co.uk

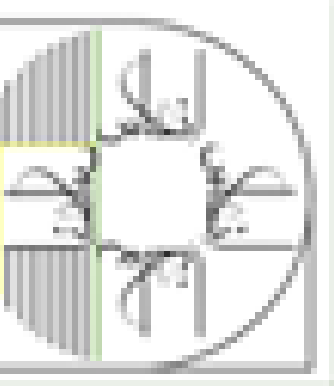

INTRODUCING SUPREME CONCERTO THE NEW MOTTLED STONE-EFFECT SURFACE FROM STARON

Added to Staron's vast array of premium solid surfaces at the beginning of 2020, Supreme Concerto is guaranteed to enhance any interior. Whether used in residential homes or within the commercial sector, the unique stone-effect surface is designed to make a statement.

Supreme Concerto joins the brand's Supreme Collection, which is comprised of fourteen individual finishes. Inspired by nature, the collection is made up of veined patterns, smooth colours and sporadic wave-like markings in muted tones to offer a versatile surface designed to work in any interior.

Featuring wash-effect shades of brown, ash, white and grey with minute textured flecks, the detailed surface provides a beautiful stone-like structure. Pair with light coloured kitchen walls and units, or white washbasins in bathrooms for a striking contrast.

Perfect for use within the home as well as in commercial spaces, the award-winning sophisticated blend of natural minerals and thermosetting acrylic polymers ensure non-porous, heat and scratch resistant qualities for the ultimate hygienic surface. Offering complete design flexibility, Staron is widely used across hotel, office, restaurant and retail sectors due to its exceptional qualities.

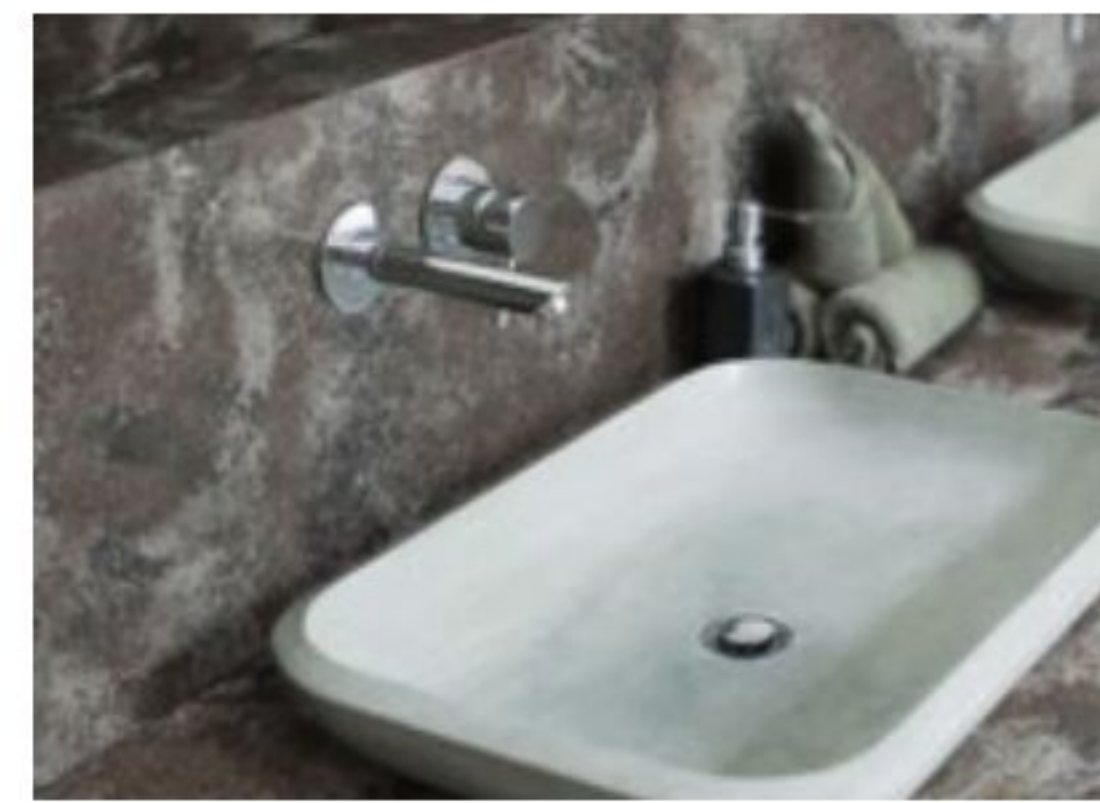

Staron is priced from £350 per m² (based on a fabricated kitchen worktop to a basic specification with upstands)

www.staron.com

PREMIER
LOFT=LADDERS



Counter-balanced
for **easy operation**

Thermally insulated to
keep in the warmth
(U value 0.77 W/m²K)

Strong, robust & durable
concertina ladder for
safe access
(load rating of 150 kg/tread)

4-point latching system
for an **airtight seal**
(class 4 certified)

Learn about the versatile Ecco Loft Ladder...
www.premierloftladders.co.uk/ecco

+44 (0)345 9000 195 | sales@premierloftladders.co.uk

The
difference
is in the
detail

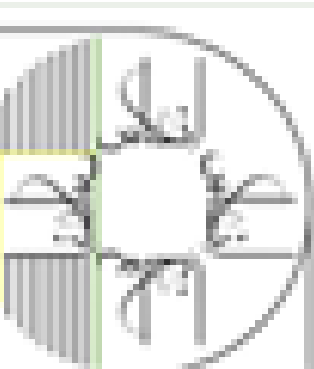



URBAN LOFTS, AMSTERDAM

BUREAU FRAAI AND BNLA ARCHITECTEN CONVERT FORMER OFFICE SPACES INTO HIGH-END URBAN LOFTS

With the conversion into high-end urban lofts Bureau Fraai & BNLA architecten made the design for the upgrade of former office spaces underneath two of in total four characteristic 60's mixed-use residential blocks of Dutch functionalist Piet Zanstra.

The existing facade of these levels with office spaces underneath the buildings were outdated and are renewed with respect to the characteristics and structure of the original design. As an addition each loft apartment is provided with a loggia.

The conversion into a total of 48 high-end compact urban lofts for young professionals, is part of the StartSmart-living concept developed by Nobillon Vastgoed. As an addition to the private lofts, part of the concept is to provide spaces for the inhabitants to meet and connect.

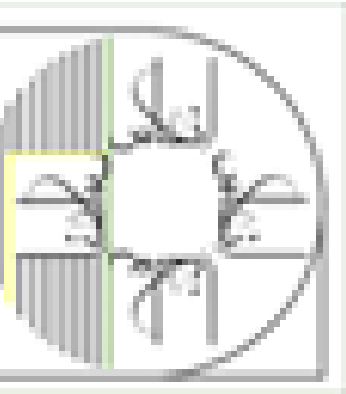

“

The conversion into a total of 48 high-end compact urban lofts for young professionals, is part of the StartSmart-living concept developed by Nobillon Vastgoed.

This originates from the believe that a healthy social-life is essential for a high quality-of-life. According to these principles the communal spaces as lobby, staircase and hallways are designed as an extended part of one's loft.

Focus of the main design concept for the interior of the lofts is the introduction of a 3D interior object containing a kitchen, a bathroom, storage space and a mezzanine with a double bed. The quality of the raw concrete structure of the existing building contrasts with the refined wooden interior objects. The co-existence of these different materials and textures captures the past and the present into a harmonic design which is both industrial and luxurious.

Status: completed 2018

Interior architect: Bureau Fraai

Architect: BNLA architecten

Client: Nobillon Vastgoed

Location: Amsterdam, The Netherlands

Casco contractor: Cooper projectrealisatie

Structural engineer: Jack Hogeboom

Façade: Componed

Interior builder: Schröder Interieurs

Photography: Studio de Nooyer

www.bureaufraai.com

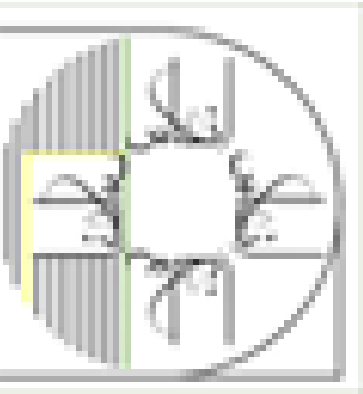

UK MANUFACTURERS OF STREET FURNITURE



POSTS - HINGED & TELESCOPIC
BOLLARDS - STEEL & STAINLESS
HOOPED BARRIERS
CYCLE STANDS & RACKS
CYCLE SHELTERS
HEIGHT RESTRICTORS
SWING GATES
ARM BARRIERS
SMOKING SHELTERS
SEATING

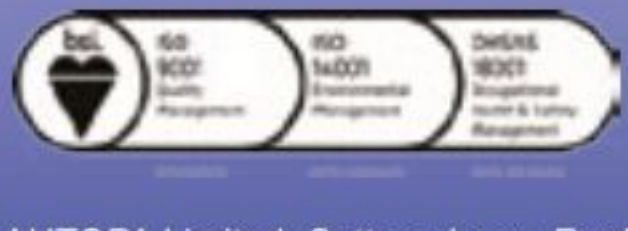

01788 550556
info@autopa.co.uk
www.autopa.co.uk

AUTOPA Limited, Cottage Leap, Rugby, Warwickshire, CV21 3XP

AUTOPA

TREX DECKING

Trex Company, the world's No. 1 decking brand, offers a solution to build with green materials whilst not compromising on aesthetics. In fact, no trees have ever been cut down to make Trex. The entire high-performance decking portfolio is manufactured from more than 95% recycled content. With high-definition wood grain patterns and rich, saturated colours inspired by the outdoors, Trex composite decking looks natural and boasts a vibrancy that remains unchanged for years. Colour options range from deep earth tones to warm umbers, spicy reds and pristine greys.



Featuring a protective shell for superior defense against severe weather and heavy foot traffic, Trex deck boards will retain their good looks even after years of wet British winters. Just an occasional sweep and soap-and-water cleaning is all that is needed to maintain a Trex deck for decades.

Trex decking is available locally through Arbordeck stores at <http://www.arbordeck.co.uk/>.

Visit <http://uk.trex.com> for more information on low-maintenance, high-performance Trex products.

Traditional style... modern purpose

EV Charging - Regeneration - Parks - Sports & Leisure



We have a range of styles, finishes and sizes to suit all purposes and budgets. With our Bespoke build and Pre-Wired services we're your 1st choice for high quality Feeder Pillars and Electrical Enclosures. Call us or visit the website for more information.



Tel: 0333 666 2122
Email: info@fisherandcompany.co.uk
Website: www.fisherandcompany.co.uk

DANDELION STONE TROUGHS



Herewith a picture of a very unique Dragon Stone Arch which would make either a truly stunning fireplace, garden water feature or could be incorporated within a 'Grand Design', such as a 'Folly'.

DANDELION specialise in supplying Antique Architectural Stone Curiosities, such as : • Old York Stone Gargoyles
• Old Standing Stones • Old York Millstones

Cowling in Craven, North Yorkshire BD22 0NW.
01535 637153 - 07971 906105

www.dandelionstonetroughs.co.uk



Products that tell a story

Plastic waste saved from landfill since 1995 and turned into award-winning second life products.

Plaswood is the **sustainable, durable** and **maintenance free** alternative to traditional materials.



Sustainable



Non Staining



Recyclable*



Long Lasting



UV Stable**



Maintenance Free



Durable



Weather Proof



Versatile



High Strength

Maintenance Free Decking



Our Products

An extensive range of sustainable solutions.

Plaswood products are made from recycled plastic, are maintenance and splinter free, rot and weather proof.

Begin your journey towards a maintenance free garden, visit us at www.plaswood.eco or call us on +44 (0) 333 202 6800



Deck Chairs



Terrace Set



Planters



Space Saver



Composters



Full range includes: Tables • Benches • Bins/Composters • Planters • Garden furniture • Edging
Decking • Fencing/Gates • Signage • Lumber • Boardwalks

a brand of

آموزشگاه انعکاس منبع جدیدترین اطلاعات، مقالات و دوره‌های آموزشی دکوراسیون داخلی

Enekas.Academy

Enekas.Academy

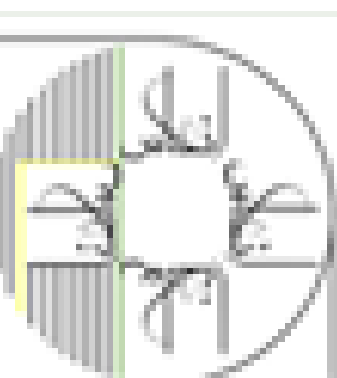
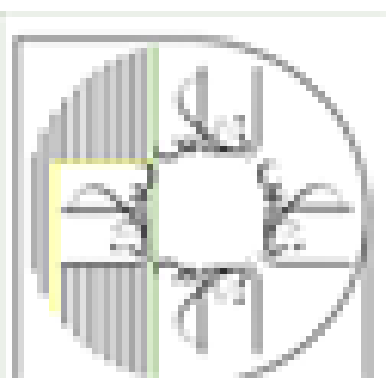

WHAT MAKES A LIFT A FIREFIGHTER LIFT?

Lifts are the safest form of vehicular transport in the world, the UK abide by various minimum design safety requirements which today are:

- EN81-21: New passenger and goods lifts in existing buildings.
- EN81-28: Remote alarm on passenger and goods passenger lifts.
- EN81-70: Accessibility to lifts for persons including persons with disability.
- EN81-71: Vandal resistant lifts.
- **EN81-72:** Firefighting lifts.
- **EN81-73:** Behaviour of lifts in the event of fire.
- EN81-80: Safety rules for the construction and installation of lifts.

Many UK high rise buildings have been built long before the current British standards and even their predecessors in the early seventies. Lift design was a matter for architects, building design approval and customer requirements. A few standards and design guides were available but not nationally approved specifications.

The most dangerous misunderstanding iKONIC Lifts have come across, amongst many firefighters over the years, is that a lift with "Fire service over-rides" are Firefighting lifts, they certainly ARE NOT!

The most common reason for this belief is the The fireman's switch (lift over ride switch) one of the earliest control features, located in the lobby/entrance or at ground floor level, that can be utilised by the fire service. This can be used by breaking glass, a crescent switch, yale key switch, etc. Today is most commonly via a drop key. The most common effect is to over-ride all floor calling, to return the lift to the floor where the fireman's switch is located, then to open the doors and for them to remain open.



iKONIC Lifts cannot stress enough, unless specifically designed, and compliant a lift is NOT a Fire Fighter Lift!

A very specific design is required with many additional built in safety features. The design standards for firefighting lifts are covered in EN81-72 and the general requirements are as follow:

- Minimum size is 8 persons (630 kg).
- 1100mm wide x 1400mm deep.
- or For Evacuation, 13-person 1100mm x 2100mm.
- Doors 800mm wide Minimum.
- Reach furthest floor from FSAL in 60 seconds up to 200m travel.
- Built in Water protection.
- Escape hatch and ladder.
- Communication system between the lift car and the FSAL.
- Dual/backup power supplies and shall be protected.
- Dedicated protected lift shaft.
- If distance between consecutive landing doorsills exceeds 7m, intermediate emergency doors shall be provided.

When activated the lift Control system will:

- Isolates all landing calls and cancels car calls
- Lift car returns to FSAL and parks with doors open
- Shaft and machine room lighting is switched on

Functionality Becomes Limited to:

- Single call operation
- Doors remain closed on arrival
- Constant pressure control of doors
- Communication device operative between Lift Car, machine room and FSAL

For more information contact iKONIC Lifts
Telephone: 0203 376 6440 | Email: sales@ikoniclifts.co.uk
www.ikoniclifts.com

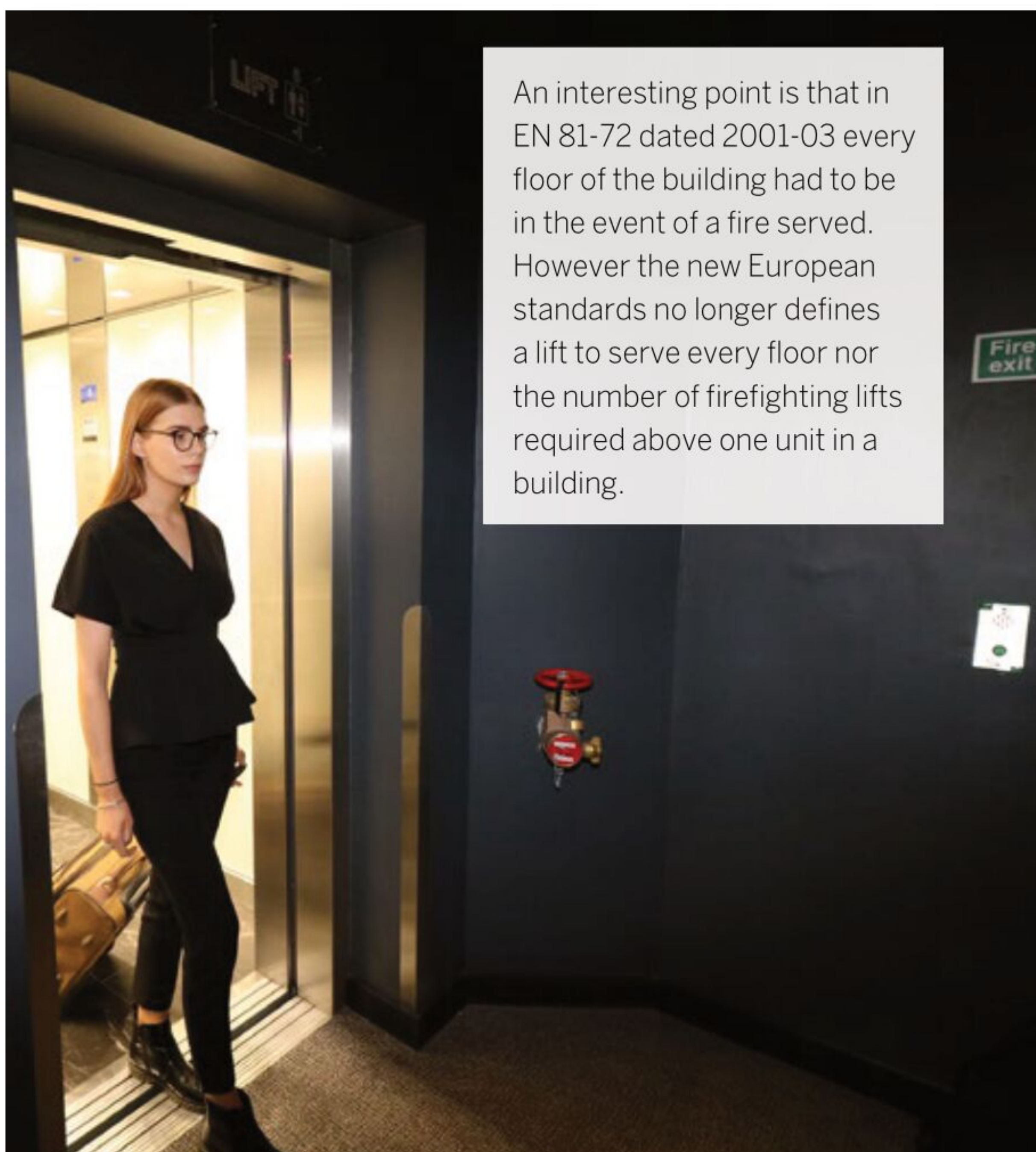

An interesting point is that in EN 81-72 dated 2001-03 every floor of the building had to be in the event of a fire served. However the new European standards no longer defines a lift to serve every floor nor the number of firefighting lifts required above one unit in a building.

OUT OF THIS WORLD



iKONIC VERSATILE VENUS *Scenic Passenger Lift*



Ideal Solution For

✓ New Construction

✓ Retail

✓ Light Wells

✓ Iconic Buildings

✓ Hospitality

✓ Listed Building

✓ Office

iKONIC Versatile Venus Scenic Lift simply produces the WOW factor effortlessly. Perfect for iconic, listed, and prestigious buildings in both domestic and commercial environments.

The Venus makes a fantastic talking point in any building with simple stunning results, supplied with specific designed structures dependant on the application use and if the lift is intended to be located internally or externally.

Making a great focal talking point in shopping centres, museums as well as providing a great solution in preserving light wells in listed buildings, with simply stunning and impeccable performance results.

A machine room is not required which allows for even greater design capability, our whole range of lifts features open protocol. You can guarantee minimal acoustic levels and enjoy maximum comfort with the added options to make the interior designs and elements such as the lift car floors and handrails, bespoke to your desire!



Sophisticated Lift Thinking

آموزشگاه انعکاس منبع جدیدترین اطلاعات، مقالات و دوره‌های آموزشی دکوراسیون داخلی

Enekas.Academy

Enekas.Academy



CONSTRUCTION COMPLETES ON WESTMINSTER COPPER-CLAD DEVELOPMENT

LATIMER, THE DEVELOPMENT ARM OF CLARION HOUSING GROUP, HAS ANNOUNCED IT HAS COMPLETED CONSTRUCTION AT NOMA, ITS STRIKING COPPER-CLAD DEVELOPMENT, NORTH OF MAIDA VALE, WESTMINSTER

The 248-home scheme on Kilburn High Road includes 109 apartments for private sale and 139 affordable homes available via Westminster Council. All apartments have now been completed to a high standard, alongside its iconic copper façade and communal spaces.

NOMA has been designed to support the local community, with a variety of amenities including expansive landscaped communal gardens which make up more than 50 per cent of the total site, and a community hub space to be enjoyed by residents of all ages.

The Latimer site also features a 12-hour concierge service and its own on-site high-tech gym designed by Technogym fitness specialists, with private studio for PT sessions, yoga, or even urban massage, to facilitate easy living for all.

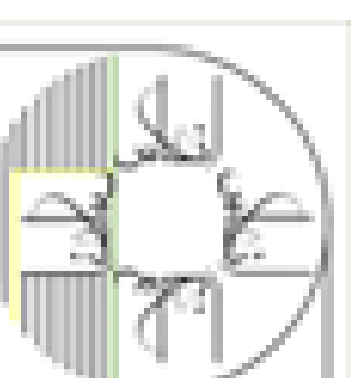
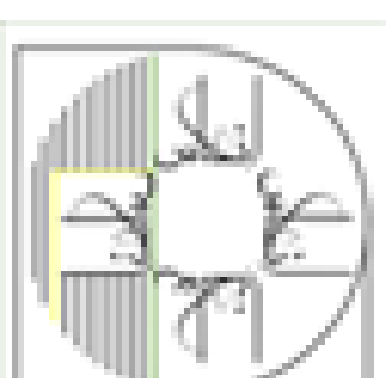

“

Over half the site is dedicated green space to offer a peaceful oasis in the middle of the city.

Construction was completed by 31st March and its first residents have already begun to move into their new homes.

Krete Luca, London Sales Director at Latimer, said: “NOMA has been carefully designed to bring a unique offering to the London property market. With its beautiful copper cladding, luxury finish and all high-grade fittings and finishes included as standard, this is an excellent opportunity for buyers to purchase a Westminster home with excellent Zone Two transport links.

“At Latimer, we’re committed to supporting the long-term growth of communities which is why NOMA has been designed with its residents in mind. Over half the site is dedicated green space to offer a peaceful oasis in the middle of the city, and with its transparent pricing, we hope many buyers will be able to put down roots in the Maida Vale area who may have previously felt alienated from home ownership in London.”

Latimer aims to help tackle the housing crisis by increasing its pipeline of new build developments, with profits reinvested into building more affordable homes and supporting communities.

There are still two, three and four bed flats available, starting at £765k, so those wishing to become part of NOMA’s community still can. For more information on the scheme, call 020 7205 2496 or visit noma-westminster.com.



CUPACLAD IS THE LOGICAL CHOICE FOR STRIKING LEANING HOUSING BLOCK

London-based architect, WHAT_Architecture has specified CUPA PIZARRAS' CUPACLAD 101 Logic as the ideal rainscreen cladding system for a new and unusual housing block in Peckham. Crucial to this decision was the system's ease of installation and its natural aesthetic, which helped the contemporary design to also complement the surrounding and traditional urban landscape.

Located on the corner of Costa Street, the project is part of a wider scheme to regenerate the Peckham area. The unusual housing block has been designed to look as if it is falling. It is constructed with a cross laminated timber interior superstructure, while the form of the upper half of the building is a leaning mansard, angled towards the adjoining garden at a 72-degree angle – creating a truly striking aesthetic.

WHAT_Architecture looked at a variety of materials during the planning process, before selecting natural slate. A completely natural material, slate provided imperfections and rough edges, which suited the desired aesthetic for the housing block. In addition, the slate helped to reflect the character of the surrounding, more traditional buildings.

Antony Hoete, Director of WHAT_Architecture commented: "We have used slate here to do things that brick just could not do. The brick components of the building weigh about 150 kg per square meter, whereas the slate comes in at just under 30 kg per square meter. By using lightweight slate, we have been able to create the leaning effect we desired with an incredibly robust building material.

"Furthermore, the metal-bracketed CUPACLAD system allowed us to hide the services behind the cladding and also reinforced our idea of connecting the contemporary with the traditional."

CUPA PIZARRAS' CUPACLAD 101 Logic slate rainscreen cladding uses a single aluminium fixing system with self-drilling screws designed to ensure an optimum cladding installation, while remaining invisible to the eye, to avoid impacting the overall design.



The 7.65mm slate used is a robust and weatherproof roofing material, which has passed the British Board of Agrément (BBA) certificate for impact testing, ensuring that the slate has long-term durability and will remain watertight.

"CUPACLAD is a modern and easy installation system. We chose the CUPACLAD 101 Logic as its design layout also reflects that of the brick base, without actually using brick," said Diana Kulacka, Project Architect from WHAT_Architecture.

Terry Collins, Specification Manager at CUPA PIZARRAS commented: "When approached to help find a solution for Costa Street, we started by undertaking a site visit and survey to ensure we would absolutely understand the architectural vision and how to make it a working reality with slate.

"It's incredibly important to us to have a close and collaborative process, as this helps to ensure the finished project is exactly as desired. Helping us to achieve this is our London showroom, which is a valuable space where architects can view the materials and talk to our experienced team."

Quarried from CUPA PIZARRAS' own quarry in northern Spain, the slate used on CUPA PIZARRAS' CUPACLAD systems requires no chemicals or heating involved in its extraction making it a sustainable material choice as well which, combined with the modern aluminium cladding system, is capable of redefining the aesthetics of façades.

Taylor Maxwell is now the exclusive UK distribution partner for CUPACLAD. When specifying this innovative cladding solution, you will not only have the support of Natural Slate experts but also from a team with over 60 years' experience in supplying external façade solutions to the UK construction industry.

For more information on CUPACLAD natural slate, please visit www.cupapizarras.com/uk/rainscreen-cladding/.

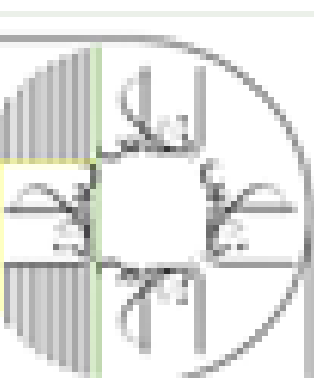
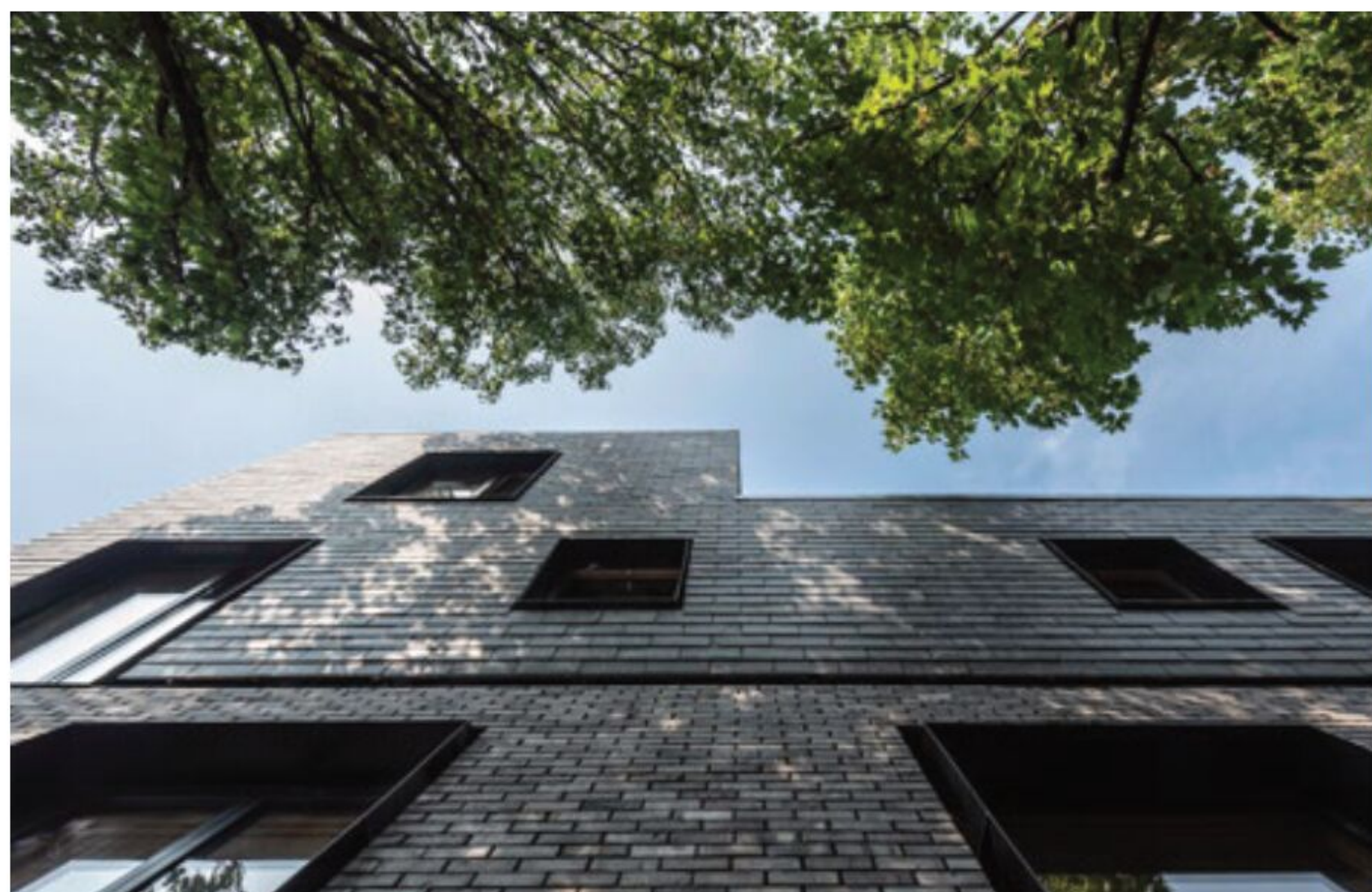



CUPA PIZARRAS

The world leader in natural slate



آموزشگاه انعکاس منبع جدیدترین اطلاعات، مقالات و دوره‌های آموزشی دکوراسیون داخلی

 Enekas.Academy

 Enekas.Academy

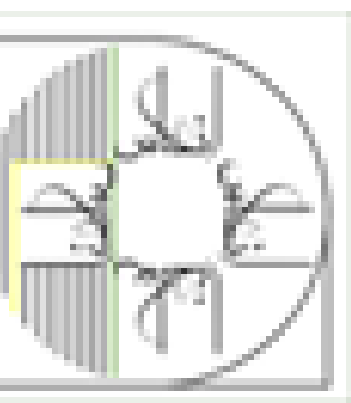
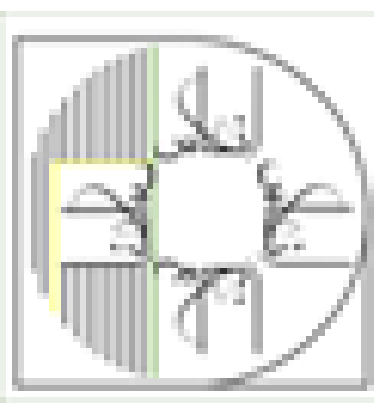

SHINING A LIGHT ON THE WORLD'S LARGEST HANGAR

A large new hangar for American Airlines has been completed at Chicago's O'Hare International Airport using Kalwall® translucent cladding to provide natural daylight to form signature 'light bars' at each end.

The hangar cost \$251million and was designed by architects Ghafari Associates. At over 185 metres long, 90 metres wide and 36 metres high, it took almost three years to build and is the longest clear-span, dual entry aircraft hangar in the world.

The clever use of Kalwall means that natural diffused daylight is transmitted deep into the interior space. At the same time, it provides security and additional thermal insulation, thereby reducing the reliance on HVAC systems and artificial lighting. In addition, the Kalwall minimises light pollution out of the building and stops the sun reflecting off the surface. These were both important considerations because the building is sited near busy operating runways. These aspects also helped the new hangar win an honourable mention in the 2019 Airports Going Green Awards.

Aesthetically, the Kalwall also works well on this project. The lightweight panels fit seamlessly with the building's primary steel supports, which positively impacted the bottom line since there was no need for a secondary structural system. The 'shoji' pattern of the Kalwall grid also marries up with the



exterior cladding and shutter doors giving the whole building a sense of uniformity.

Kalwall, exclusively available in the UK and Ireland from Structura UK, is a popular choice for all types of building around the world. In the UK, it has also been used for several airport projects including Heathrow, Gatwick and Glasgow. The cladding's inherent strength and heavy duty impact resistance make it ideal for secure locations. U-values as low as 0.28W/m²K, equivalent to a cavity-filled solid wall, can be achieved by including translucent silica aerogel within the panels. Options such as explosion venting and blast resistance can be incorporated as required.

Case studies and technical information are available from Structura UK Ltd on tel: 01233 501 504 or by visiting www.structura-uk.com/kalwall

seal it

ONE COAT

ROOF SEAL

100% WATERPROOF BARRIER

the flexible cool roof

Solvent-free and non-flammable, Seal It Liquid Membrane is designed for professional roofing applications as the ultimate alternative to bitumen based and GRP roofing membranes: ideal for all existing roof substrates. With outstanding water resistance and weather proofing it is self-levelling, gap-bridging, non-shrinking and non-cracking.

You can even apply it when it's wet!

Full available system comprises: Primer, Reinforcing Mat, Sealer and Accelerator. Available in either white or grey and in stock now.

25

YEARS

GUARANTEED

Unit G16, River Bank Way, Lowfields Business Park, Elland, West Yorkshire HX5 9DN
 Tel: +44(0)1422 315300, Fax: +44(0)1422 315310
 Email: sales@bond-it.co.uk Website: www.bond-it.co.uk

THE SKY IS THE LIMIT WITH BILCO UK'S SKY FLATGLASS SMOKE VENT

Bilco UK is supporting specifiers, architects, engineers and facilities managers in achieving the highest standards in safety, efficiency and aesthetics with the launch of its new SKY Flatglass smoke vent.

The innovative product, which can be installed on flat roofs across a wide range of commercial and residential building types, offers professionals a diverse 'three in one' solution, as it can be utilised as a smoke vent, roof access hatch and rooflight.

Suitable for installation on new build developments or retrofitted onto existing projects, the CE marked smoke vent can be wired into the Building Management System to provide a fully compliant solution that will automatically open in the event of a fire or smoke.

The SKY Flatglass is fully compliant with all relevant building regulations outlined in Approved Document B and is tested to BS EN 12101-2 to support professionals in achieving constant compliance in line with latest legislations.

Unlike many competitor products that use polycarbonate, the smoke vent features a single leaf flat glass sliding cover, offering a functional yet aesthetic approach to natural smoke ventilation, particularly for exposed areas where a hinged opening may not be suitable.



The streamlined flat glass enables the smoke vent to also be utilised as a rooflight, flooding interior spaces with natural light. When used in conjunction with a fixed ladder, it can also be utilised as a roof access hatch, opening to 180° for safe and secure access.

The latest range has been tested for impact resistance, meeting standard BS EN 1873: 2014 Class SB1200. This is achieved through its innovative construction, which features a top layer of toughened glass, spacer filled with 90% argon and a low-E laminated glass layer. This is combined with a lightweight external white powdered coated aluminium frame and internal frame of reinforced PVC.

For further information on Bilco UK's complete range of roof access solutions, visit www.bilcouk.co.uk or call 01284 701696.

A "BUBBLY" FACADE IS PART OF A MAJOR DEVELOPMENT PROJECT

Carlsberg Group Headquarters
Office building, Copenhagen, Denmark
Architects: C.F. Møller Architects

A massive transformation of what is (probably) the most famous brewery site in the world, has resulted in a stunning and vibrant new city district in the heart of Copenhagen. With a combination of both modern and historic architecture, the extraordinary Carlsberg City District will provide both office and residential buildings, as well as cafes, shops, hotels and schools.

The Carlsberg brand is synonymous with thirst-quenching drinks, so it is fitting that the facade design for the entrance of their new headquarters depicts refreshing golden bubbles, leaving you to imagine your favourite Carlsberg tippie. The facade was manufactured and supplied by RMIG using RMIG ImagePerf to create the pattern of the bubbles.

Technical characteristics

Raw material: Aluminium
Pattern: RMIG ImagePerf
Thickness: 3.0 mm
Finishing operation: Bending
Surface treatment: Anodising D1(AC-Gold)20 MY

www.city-emotion.com

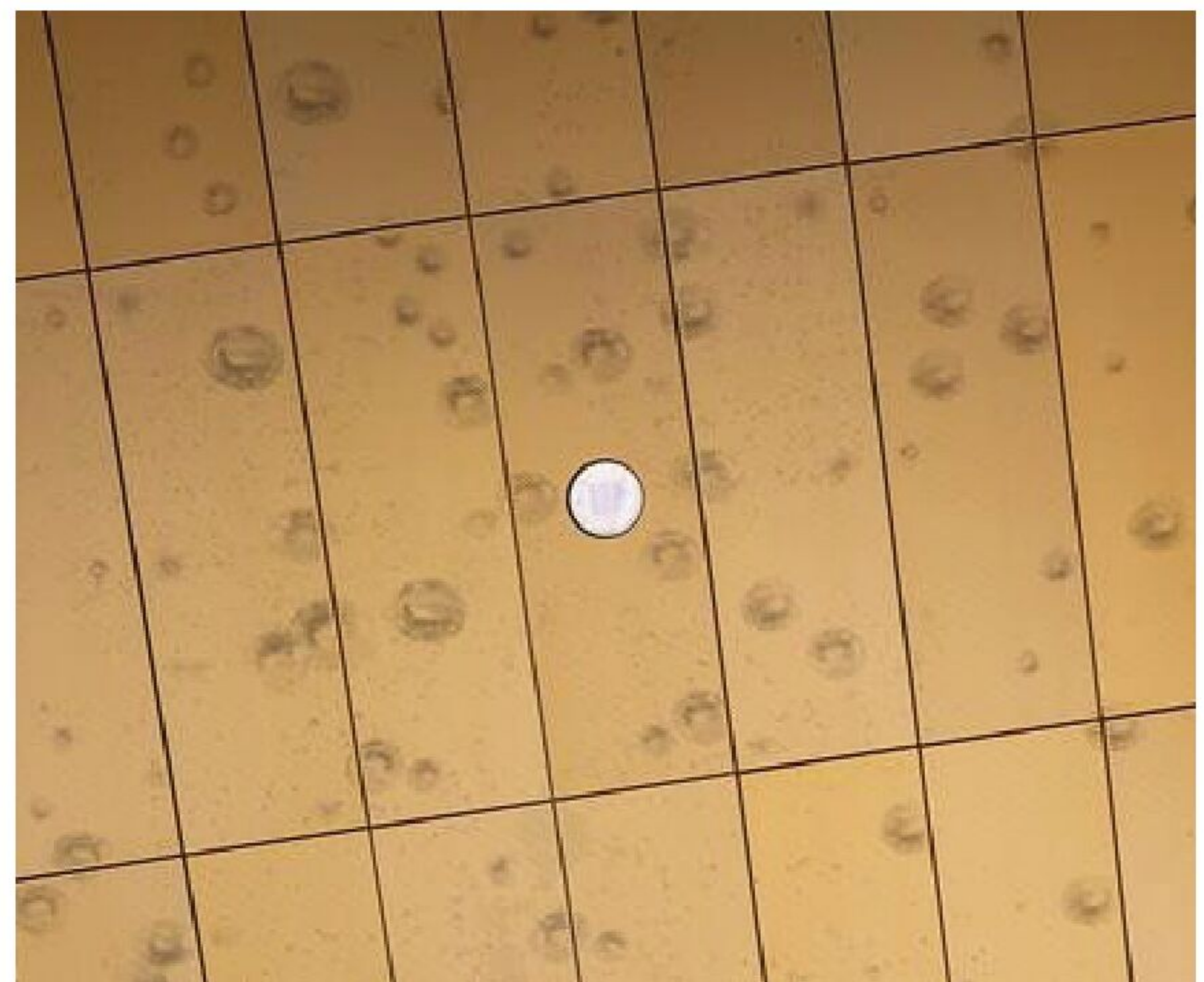



EDWARD STREET QUARTER BUILT WITH WELLBEING IN MIND

EDWARD STREET QUARTER, THE NEW NEIGHBOURHOOD COMING TO CENTRAL BRIGHTON, IS BEING BUILT WITH WELLBEING AT THE HEART OF ITS DESIGN

The largely pedestrianised development will encourage healthier, safer and more resilient communities by providing spaces to relax, to get active and to socialise.

According to mixed-use developers First Base, pairing workspaces with homes and social spaces which are flexible helps to create activity throughout the day and evening.

For example, break-out areas, green terraces and a shared community clubhouse will all provide flexible meeting and social spaces whilst the reopened Mighell Street and adjacent public courtyard will provide plenty of casual space to relax and enjoy. These spaces will have the potential to be used in the evenings or at weekends by community groups and will accommodate a variety of curated functions throughout the year, from local farmers markets and Christmas fairs to art shows and film screenings.

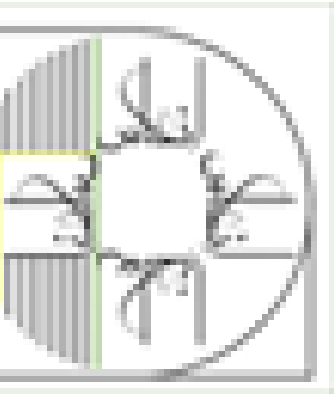

“

We have taken great care to design spaces that will promote community engagement and be a catalyst for social wellbeing.

First Base has also invested in key initiatives to promote physical and social wellbeing, including an exemplary cycle scheme to encourage healthy living and zero-carbon commutes, and District, a community engagement app, which will be used to connect people within Edward Street Quarter through the sharing of events, services, discounts and news.

Daniel May, Head of Design at First Base, explained, “The boundaries of living, working and playing are blurring – so where commercial buildings used to minimise social distractions in order to enhance productivity, they now place emphasis on the wellness of the individual, mentally and physically, such that the built environment encourages social interaction and collaboration.”

“We have taken great care to design spaces that will promote community engagement and be a catalyst for social wellbeing. Edward Street Quarter represents a new neighbourhood for Brighton to work and play; we’re looking forward to making it as easy as possible for its tenants to make healthy lifestyle choices.

Emma Hards, Partner at estate agency SHW, commented: “The modern office is no longer just a place we have to turn up for the



nine to five, so the market’s prerequisites for office buildings have changed significantly over the last decade.

“We are delighted that Edward Street Quarter will deliver on these requirements and know that businesses in Brighton will be impressed with how the development is raising the bar in terms of forward-thinking office specification.”

For more information, please visit www.edwardstreetquarter.

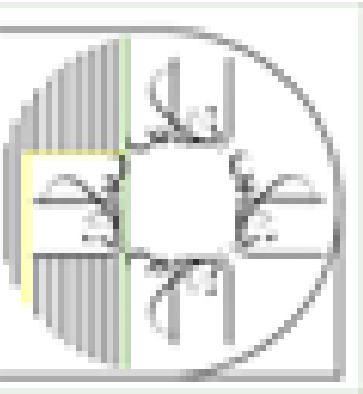



SUNRAY TIMBER DOOR DIVISION LAUNCH FIRE-SECURE®

FIRE-SECURE® is a brand new ground-breaking combined timber fire and security rated door revolutionising door safety and standards.

Within the commercial and residential sectors the increased demand on passive Fire protection and Building security has intensified following disasters such as Grenfell, which must lead to responsible product manufacturers investing into R&D to provide specifiers with accredited, tested products to meet and exceed measured performance criteria.

FIRE-SECURE® is a Timber Door which offers two unique benefits, timed protection from Fire and timed protection from physical attack.

Having invested a six-figure sum in the development of this range, Sunray have achieved the ability to provide a 30 minute fire rating on either face of the door (interior or exterior) as well as it having

the accredited LPCB SR (Security levels 1 & 2) certification.

These features are unique in their own right, however combined into one product they provide any specifier with paramount assurance to withstand the most vulnerable of applications and Passive Fire or Security Door solutions.

Without compromise the testing to the Fire-Secure® range has been our most challenging in order to pass the punishing and rigorous testing by the renowned test houses.

The result is a Timber Door which provides aesthetics with a range of colour or veneer finishes, vision panels, locking options and critically with the underlying assurance of Fire and Security protection.

For more details call our specialised team to discuss your particular project on 01252 645534

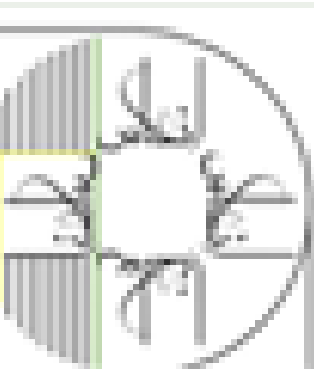

INTRODUCING...

FIRE-SECURE®

A BRAND NEW GROUND-BREAKING COMBINED TIMBER
FIRE & SECURITY RATED DOOR, WHICH REVOLUTIONISES
DOOR SAFETY AND STANDARDS.

FIRE-SECURE® is a Timber Door which offers two unique benefits, timed protection from fire and timed protection from physical attack.

Sunray have achieved the ability to provide a 30 minute fire rating on either face of the door (interior or exterior) as well as it having the accredited LPCB SR (Security Levels 1 & 2) certification.

The result is a Timber Door which provides aesthetics with a range of colour and veneer finishes, vision panels, locking options and critically with the underlying assurance of Fire and Security protection.

FIRE-SECURE® DOORS ARE THE IDEAL SOLUTION FOR

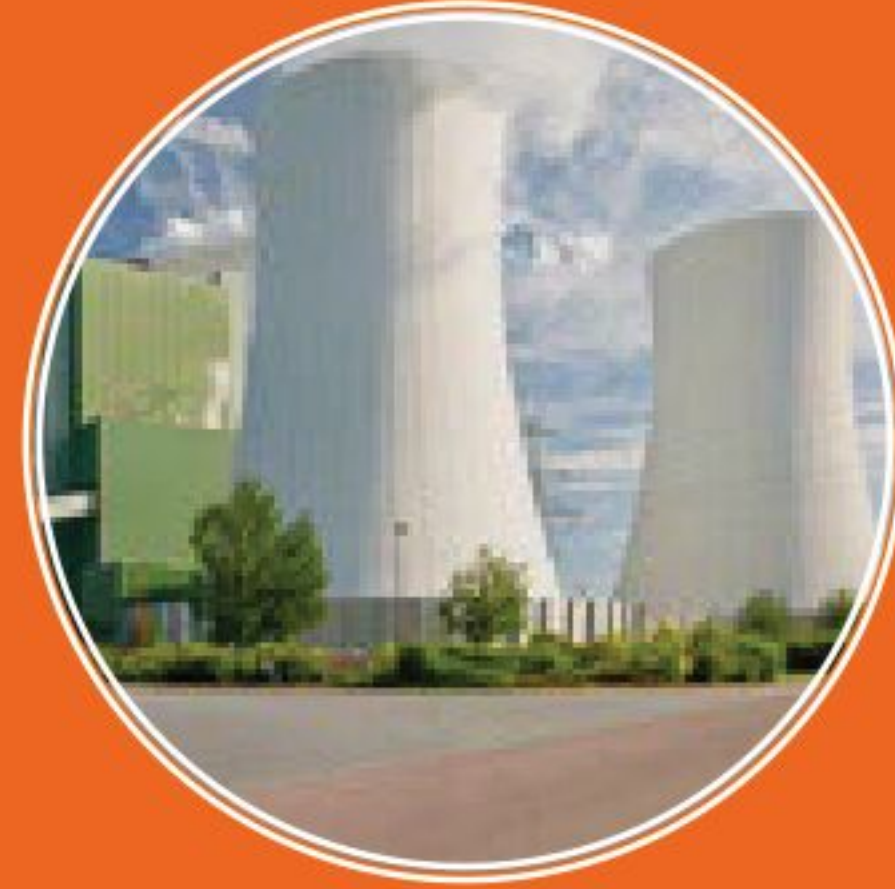

COMMERCIAL



HOTEL / LEISURE



SOCIAL HOUSING



HEALTHCARE

For more details, call our specialised team
to discuss your particular project on

01252 645534

sales@sunraytimberdoordivision.co.uk

www.sunraytimberdoors.co.uk



'IS YOUR FIRESCREEN CE MARKED?'

BY WOJCIECH BROZYNA - MD OF ALUPROF UK

Just to confirm, the 'CE mark' is a certification mark that is widely used throughout the EU. It is a declaration from a manufacturer that the product supplied is tested and meets the minimum health, safety and environmental requirements that allow it to be sold in any European member state. The product 'kit' refers to all the components that make up the product from various nominated manufacturers such as the framing system, glazing and hardware, there can be no part substitutions. The product, such as supplied in a firescreen, including doors and glazing is supplied to site complete in a fabricated form. It is the manufacture of the installed product that carries the responsibility for the CE marking by ensuring that the installer follows detailed installation instructions.



From the 1st November 2019 ALL external fire rated doorsets MUST be CE marked to both BS EN 14351-1:2006+A2:2016 - 'Windows and doors. Product standard, performance characteristics. Windows and external pedestrian doorsets'. and BS EN 16034:2014 - 'Pedestrian doorsets, industrial, commercial, garage doors and openable windows. Product standard,

performance characteristics. Fire resisting and/or smoke control characteristics.' This is now compulsory for all external fire rated doorsets and screens.

BS EN 16034 tests External Pedestrian Doorsets for fire resistance and/or smoke control, this cannot be used on its own for CE marking purposes as it must be used in conjunction with BS EN 14351-1. External Pedestrian Doorsets can include sidescreens and opening windows if required. The specified performance is then declared on the DoP (Declaration of Performance) and CE Label which is attached to the doorset. As a result of these imposed regulations, BS 476: Parts 20 & 22 can no longer be used as fire test evidence to CE mark an external fire rated doorset.

Whilst BS EN 16034 was first published in October 2014, it didn't become a harmonised standard available for use as CE mark evidence until 1st November 2016. As with all new standards, there is a co-existence period in which current standards run alongside the new standard which lasted for three years ending on the 1st November 2019.

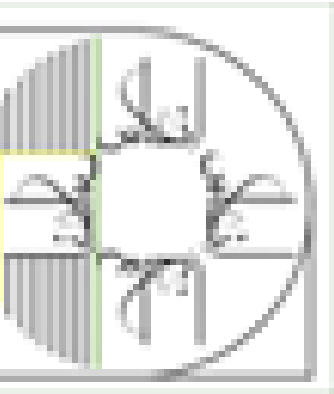

As for internal fire rated doorsets and screens we still wait for the BS EN 14351-2 'Product standard, performance characteristics. Internal pedestrian doorsets.' To be cited in the Official Journal of European Union (OJEU) which was expected to be published in November/December 2019. This means that it is currently not possible to CE mark internal fire rated doorsets and screens until the harmonisation of this standard occurs.

Whilst the product will be able to carry a CE mark offered from the systems house who undertook the testing it is important to remember that it is the manufacture of the installed product that carries the responsibility for the CE marking by ensuring that the installer follows detailed installation instructions..It is also crucial to mention that the correct interface fixing arrangements are clearly specified and applied to ensure that the spread of flame and smoke cannot circumvent the product once subject to a fire.

As aluminium remains the most widely specified material for commercial windows, doors and curtain wall, it should come as no surprise that as a leading European systems company, Aluprof offer a comprehensive range of fire rated systems.

With just a 60mm frame depth, the glazed window and door system, MB-60E EI, can achieve a fire resistance class of EI15 or EI30 according to BS EN 13501-2:2016. Complete with polyamide thermal breaks, the door system is ideal for use in both external or internal applications. Doorsets can be manufactured with both fixed lights and opening, single or double doors, to create extensive screen assemblies, but external screen assemblies cannot be CE Marked to BS EN 16034:2014.

For specification flexibility, the MB-60E EI door can also be specified with glazing thicknesses of between 4.5 to 40.5 mm and can be manufactured up to 1,400mm wide x 2,475mm high in size per door leaf. Being fully compatible with Aluprof 'MB' systems, specifiers do not have to sacrifice sight-lines between fire rated areas and normal glazing requirements.

Following two years of collaboration with Pyroguard, the MB-45EW door and framing system has been developed and rigorously tested for applications where non-insulated screens and doors are required. A first for the UK market, the slim system exceeds the current ratings of E30 and EW requirements with additional radiation reduction. Suitable for internal applications, the framing

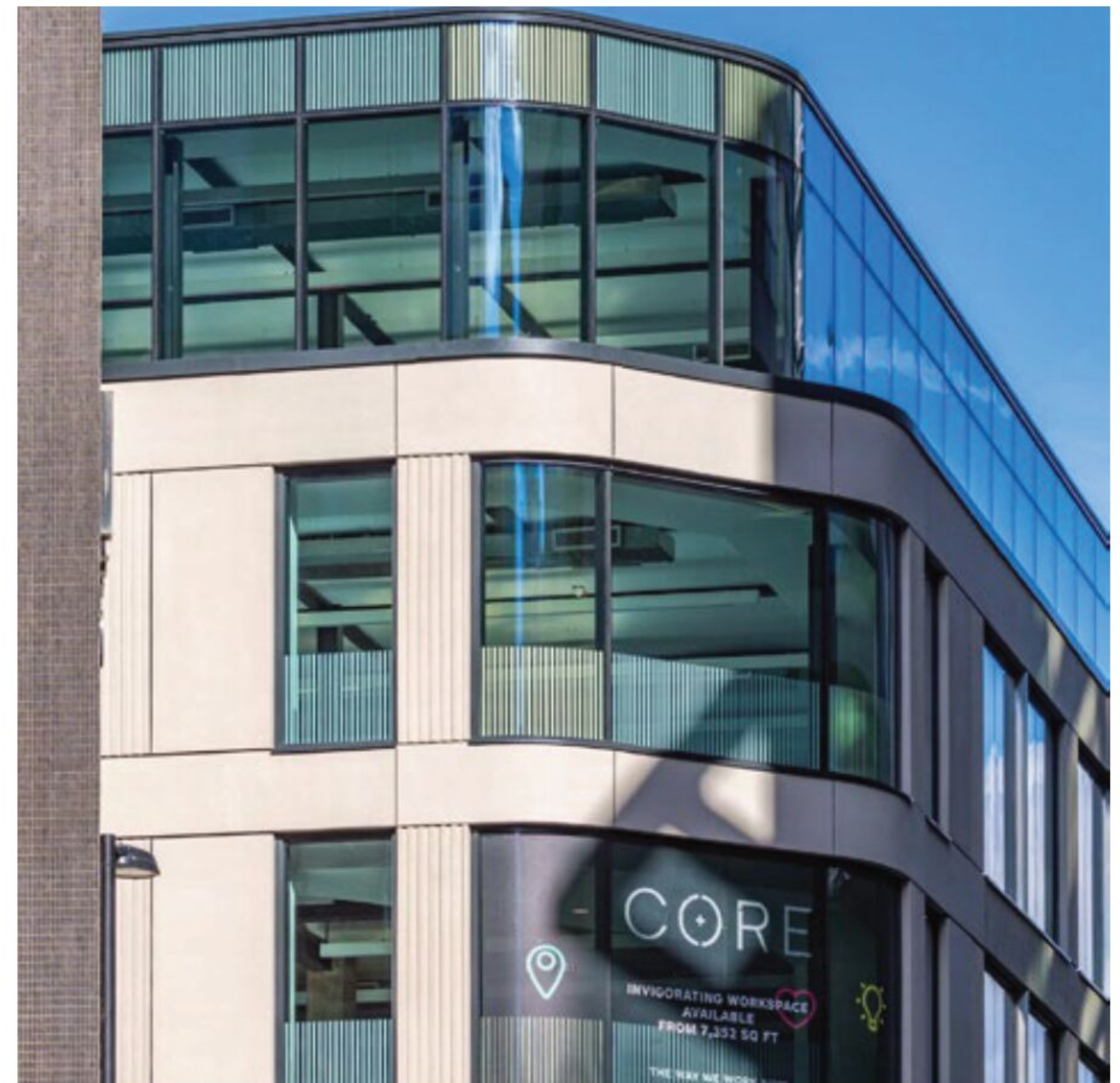

MB-SR50N EI efekt System at The Core, Manchester

system also offers a smoke-proof screen arrangement with doors, compliant with BS EN 13501-2:2016. Pyroguard Integrity Plus glass is the first fire glazing tested and certified for the new system delivering EI 15 and EW30 fire performance along with 1B1 impact protection.

Furthermore, in what is believed to be a first for the UK industry, a cap-less, fire rated curtain wall system is available and been installed on a refurbishment development in Manchester. The project, known as 'The Core', is located at 24-30 Brown Street in the city centre and uses the 'MB-SR50N EI efekt' developed by Aluprof.

A fire rating of EI60 was required on part of the new cap-less, curved glass facade on the top floor. Aluprof's new system, MB-SR50N EI efekt, enabled the architect to have a cap-less fire rated system whilst at the same time seamlessly blending in with areas which did not require a fire rating.

Aluprof's brochure entitled, 'Fire Rated and Smoke Exhaust Systems', explains in detail each product and rating. Aluprof systems offer some of the highest fire protection ratings in Europe, some reaching EI120 - that's two hours fire and smoke protection. Each system has been tested according to UK industry standards with various specialist glasses and many are fully covered by the UK's 'Certifire' certificate of approval.

Since setting up the Aluprof Office at the Business Design Centre in London, the company has rapidly grown their specification influence in the UK with their high performance architectural aluminium systems. Further expansion of the companies headquarters in Altrincham now provides specifiers with meeting facilities and an extensive showroom of commercial systems to view. With overseas growth across Europe spreading into the Middle East and firm roots already in the East of the USA, the company is becoming a global player in facade supply. Further information is available on the companies website at aluprof.co.uk or direct from their UK office in Altrincham on 0161 941 4005.

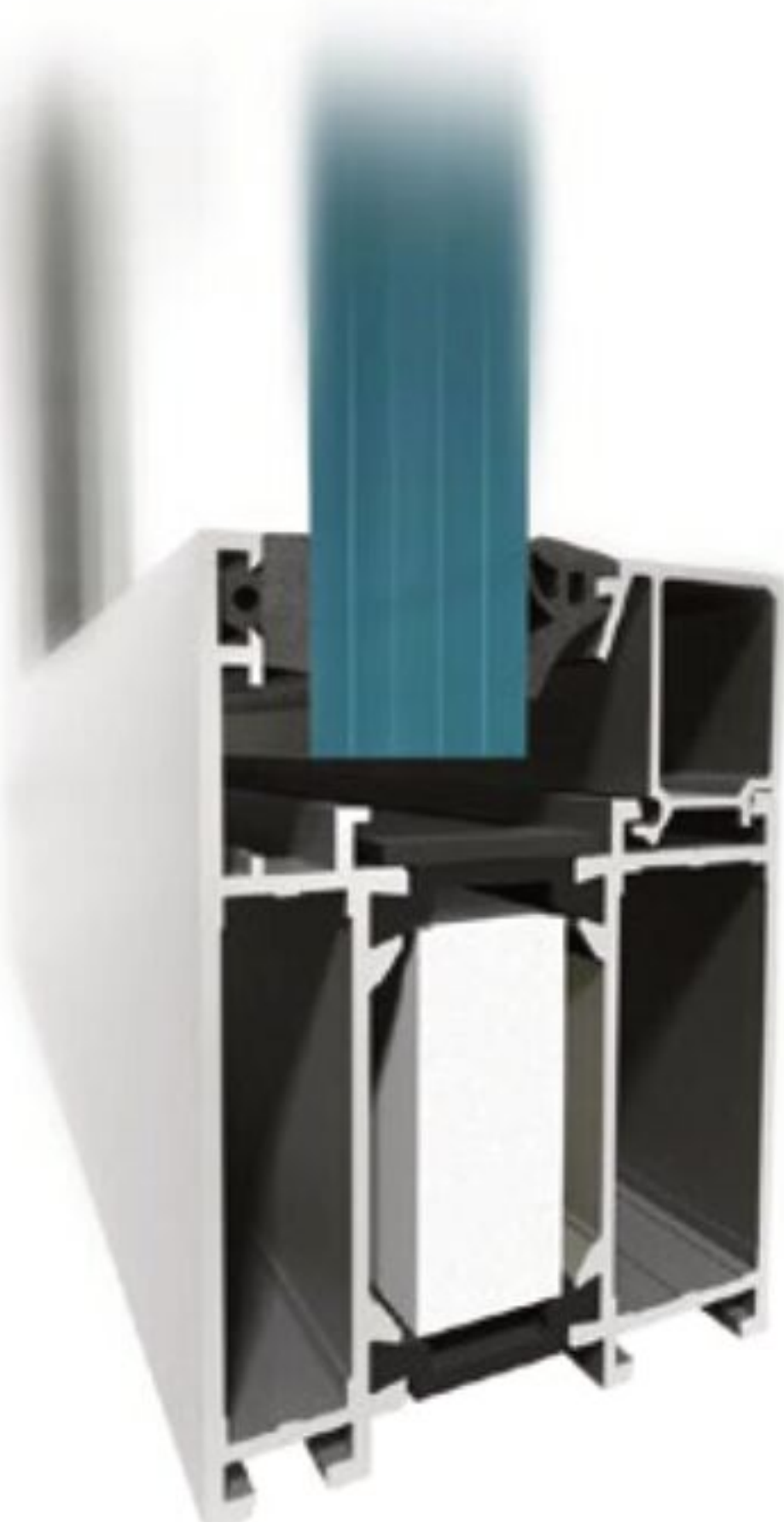

MB-60E EI - Fire Rated Door and Screen System



MB-45EW - Fire Rated Door and Screen System

www.aluprof.co.uk/en





BANISH BUDGET BLUES

MAINTENANCE FREE WALL AND DOOR PROTECTION

www.yeomanshield.com

YEOMAN SHIELD
WALL & DOOR PROTECTION
making business a pleasure for over 50 years

Improve the performance of your interiors by ending costly re-painting and repair.

for more information call 0113 279 5854 or email sallyann@yeomanshield.com

Experts in Blast Protection



Blast Resistant Litter Bins



Threat Mitigating Systems



Detonator Containment Units

ENERGETICS
Technology Ltd

manufacturing blast protection systems for civil and defence applications

enquiries@energetics-technology.com
+44 (0)1283 732 339

- airports
- train stations
- EOD teams
- stadiums
- laboratories

www.energetics-technology.com

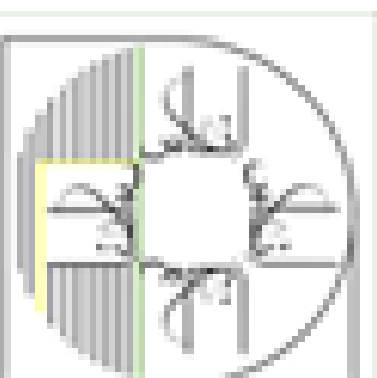
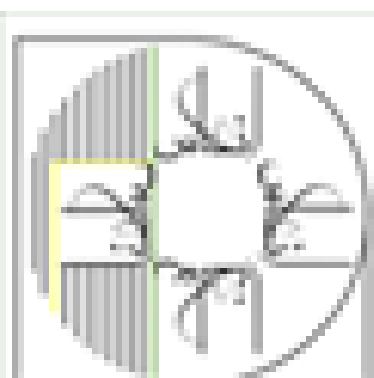



**APPLICATIONS
ENGINEERING LTD**



T: +44 (0)1825 764737
F: +44 (0)1825 768330
E: info@appeng.co.uk
www.appeng.co.uk

FIRE SPRINKLER VALVE SET 1" to 2"

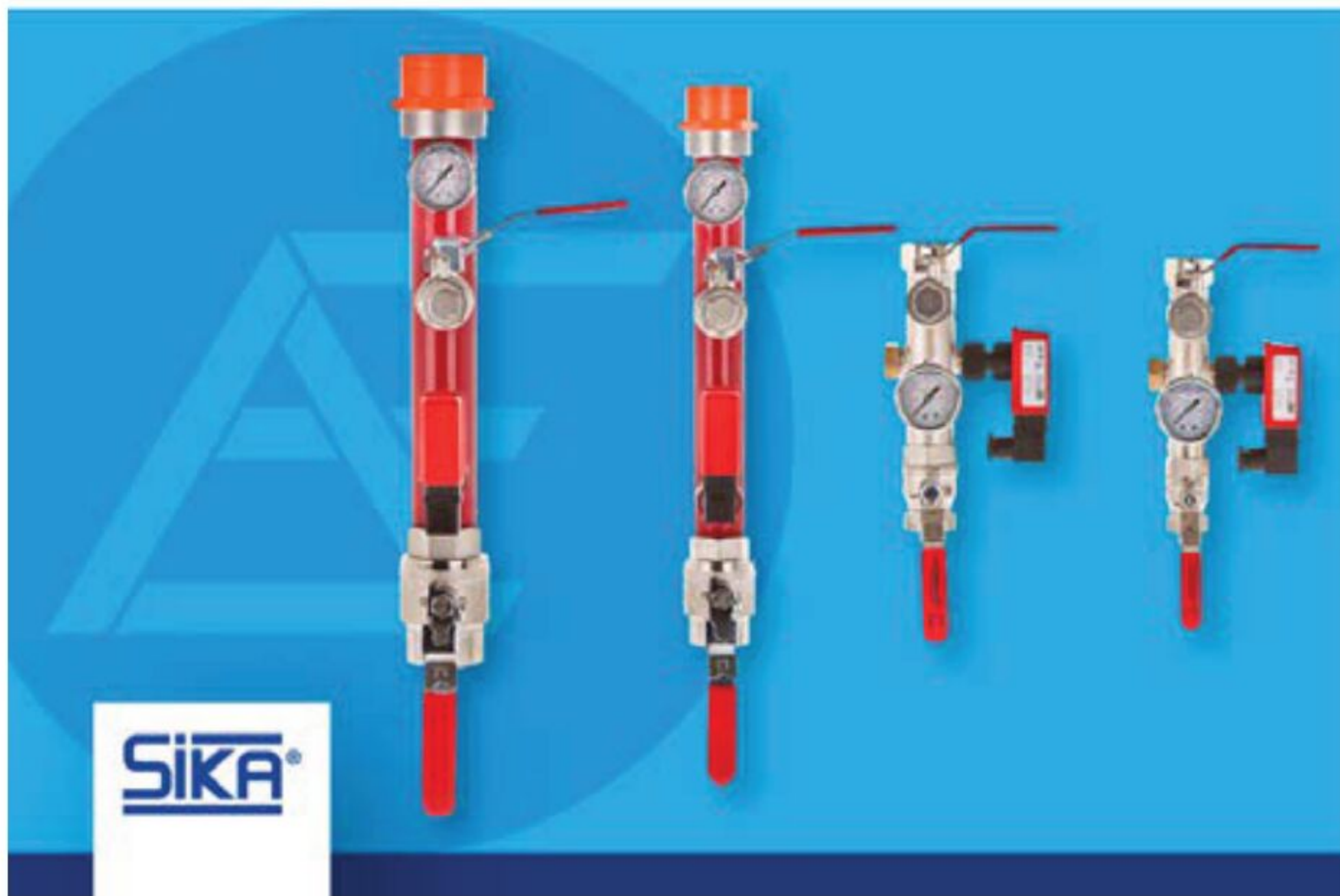

New Series of Polycarbonate & Fibreglass Enclosures within the EnviroArmour® range

AVAILABLE SOON



Help to guard important electronic equipment against vandalism, dirt, dust and grime with these IP rated enclosures



Safety Technology International

www.sti-emea.com
info@sti-emea.com

01527 520 999

YouTube LinkedIn Facebook

MANUFACTURED IN THE UK 

Fire Glass

UK

YOUR VISION IS OUR BUSINESS.

SUPPORTING YOUR GLAZING PROJECTS FROM CONCEPT TO COMPLETION *and beyond*

MIDLANDS EAST SOUTH NORTH SCOTLAND INSTALLATION



THE SAFER CHOICE

GET IT RIGHT FIRST TIME:

- ACCREDITED & CERTIFIED
- CPD TRAINING
- INTERACTIVE ONLINE RESOURCES
- ALL MAJOR BRANDS OF FIRE RATED GLASS
- TESTING FACILITIES
- FIRAS INSTALLATIONS





GUARANTEE
FIRE GLASS
FIRE GLASS

FIRE-RATED	ACOUSTIC	LAMINATED	TOUGHENED
------------	----------	-----------	-----------

INTEGRAL BLINDS

AVAILABLE IN FIRE-RATED UNITS.
PRIVACY & PROTECTION. TRUST THE EXPERTS.

 **0121 667 9089**
WWW.FIREGLASSUK.COM



HTC SPEEDGATES

...Making an Entrance

We all want to feel safe and secure in our homes and don't want the inconvenience of waiting for slow and unreliable gate systems to open and close. Here at HTC Parking & Security Ltd we understand that specifying and installing a safe, secure and reliable automatic access system is a big decision.

Benefits of Xentry Gate systems:

Fast – Our gates can open or close at approx. 1m/Second

Reliable – Our heavy-duty internal drive systems provide long term reliability

Secure – With speedy operation and robust design your entrance can be secure in seconds – With heightened security options also available.

Most Importantly SAFE – Our gates systems comply with EN13241-1 to ensure you and your family are safe and secure.

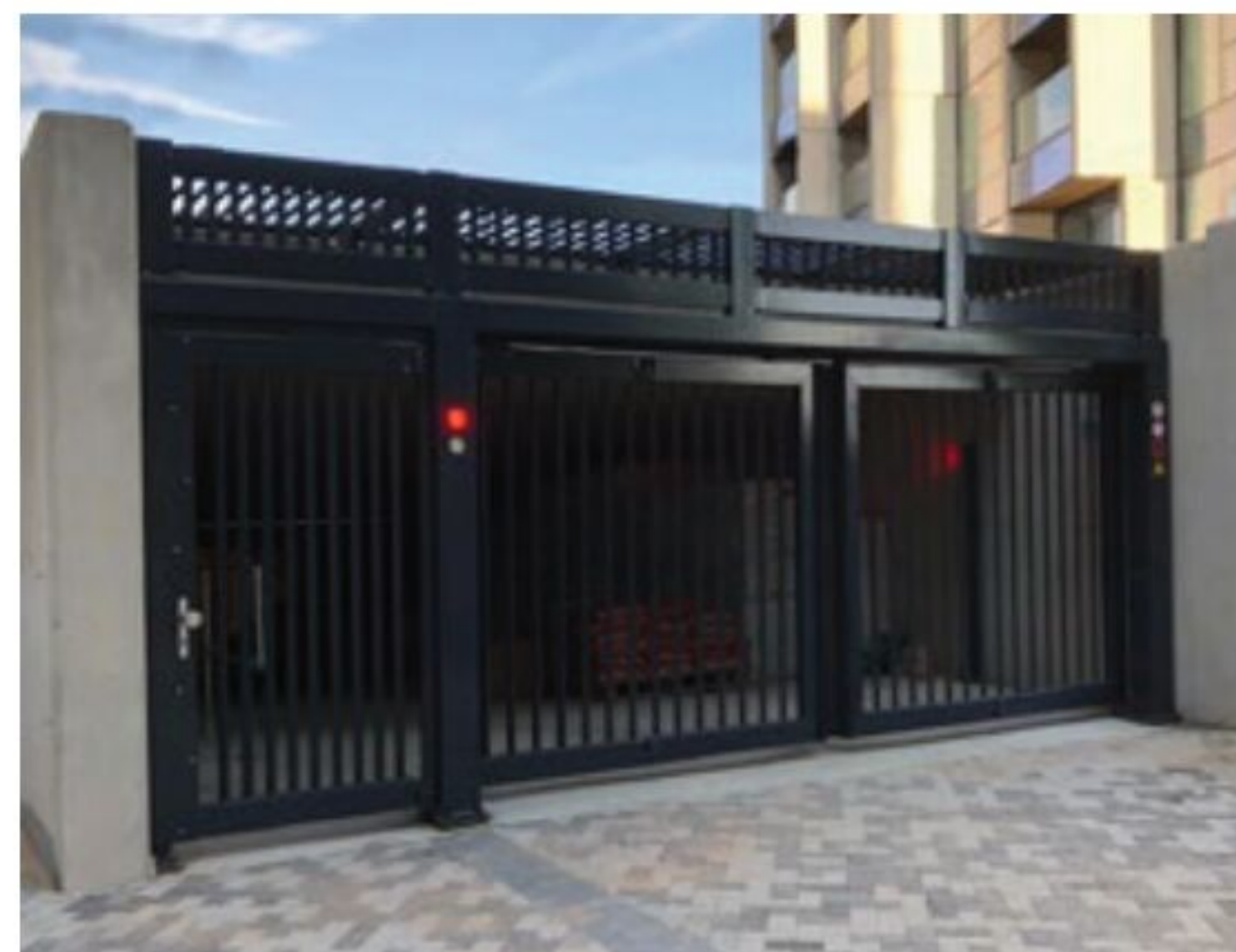

Our company has spent 25 years developing and manufacturing Bi-folding Speedgates that meet all the latest European standards relating to Automatic gates. Whether your design is to be incorporated into a future build, or to amalgamate with an older building, our fast acting, smooth, silent and stylish gate systems help you to create the perfect first impression to your residents and visitors.



HTC Parking and Security Ltd
Unit 7 Rivington Court
Hardwick Grange
Warrington, WA1 4RT



Raising Standards
Safety Assured

• Telephone: 01925 552740 • Email: Info@htc-ps.co.uk • Web: www.htc-ps.co.uk

آموزشگاه انعکاس منبع جدیدترین اطلاعات، مقالات و دوره‌های آموزشی دکوراسیون داخلی

Enekas.Academy

Enekas.Academy

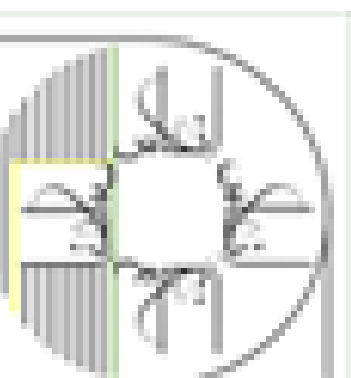
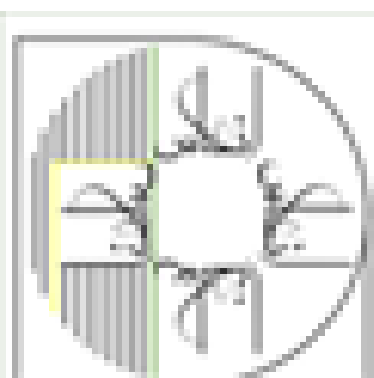



Envirograf[®]
Protecting the irreplaceable



ENQUIRE TODAY
01304 842 555
sales@envirograf.com

Envirograf manufacture the largest range of **passive fire products**

PRODUCT 55 - CAVITY BARRIERS AND TRAYS BS476 Part 20 and EN1363-1 (2012)

Fire protection for all types of cladding systems. Providing up to 240 minutes of fire protection.



SEALED CAVITY TRAY



FAST FIX CAVITY BARRIER



RSM - CAVITY BARRIER FOR RAINSCREEN FACADE SYSTEMS



CV - CAVITY STRIP BARRIER FOR TIMBER FRAME BUILDINGS

PRODUCT 110 - FIROBLOK EN13501-1 (2007) and EN1634-1 (2014)

Fire protection for services passing through plasterboard walls, ceilings and hollow brick walls. Designed to fit over existing services and can be made in any size.



2 HR PROTECTION AROUND PIPES



2 HR PROTECTION VENTILATION DUCTING



2 HR PROTECTION ELECTRICAL TRUNKING



2 HR PROTECTION CABLE BASKETS AND TRAYS



67 MINS PROTECTION FLUE PIPE PROTECTION



67 MINS PROTECTION FIRE AND THERMAL PROTECTION FOR PIPES

PRODUCT 13, 16 & 18 - COLLARS, SADDLES AND MULTI PURPOSE BOXES

Building regulations state that all services that penetrate fire-rated elements must be fire-stopped to the same fire rating as the wall, ceiling or floor.



SERVICES THROUGH COLLARS & MULTI PURPOSE BOXES



COLLARS CAN BE USED FOR PIPES AND ALSO CABLES



MULTI PURPOSE BOX BEING USED FOR DIFFERENT SERVICES

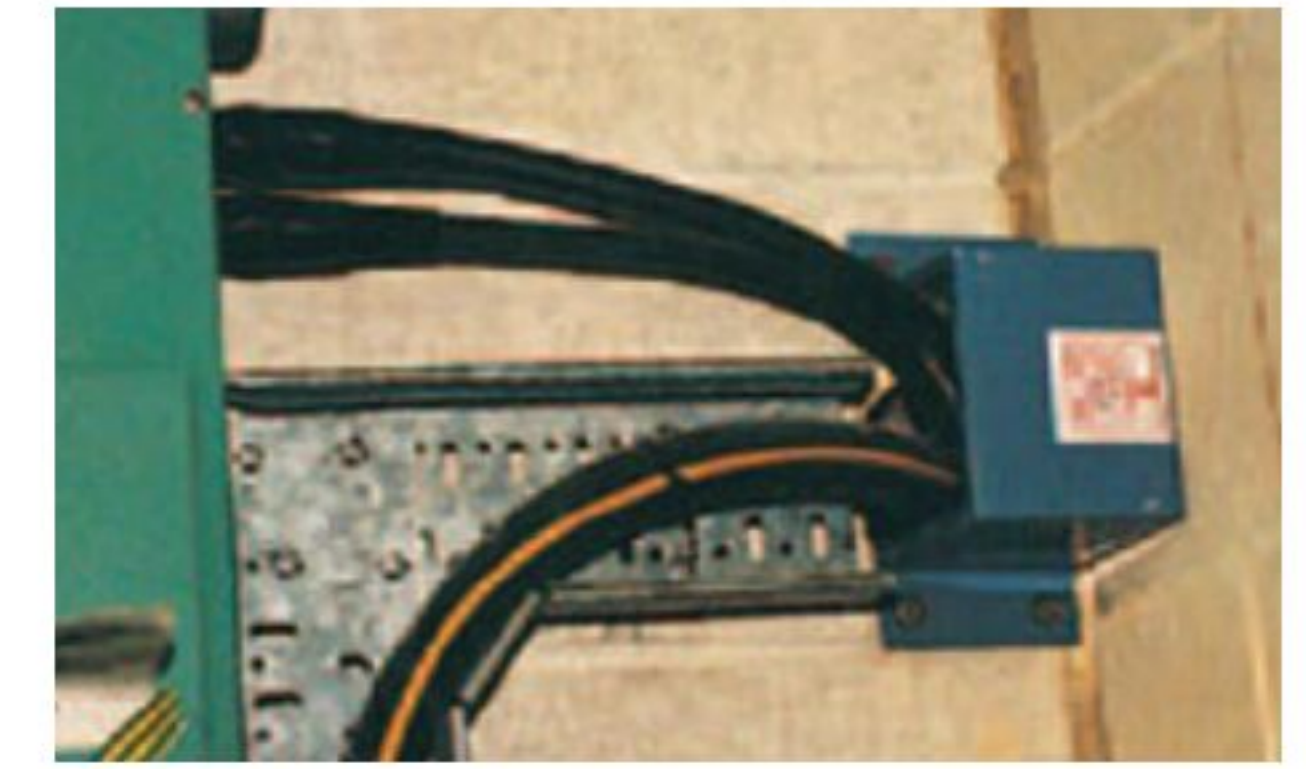

SADDLE FOR DIFFERENT TYPES OF SERVICES

FIREPROOF COATINGS



Product 42 - Intumescent Coating for 30 to 60 minutes fire protection. Available in Clear or White.



Product 92 - Fire coating for different types of timber Internal and External Class 0 & 1, SBI: B/s1/d0 and 20mins protection.

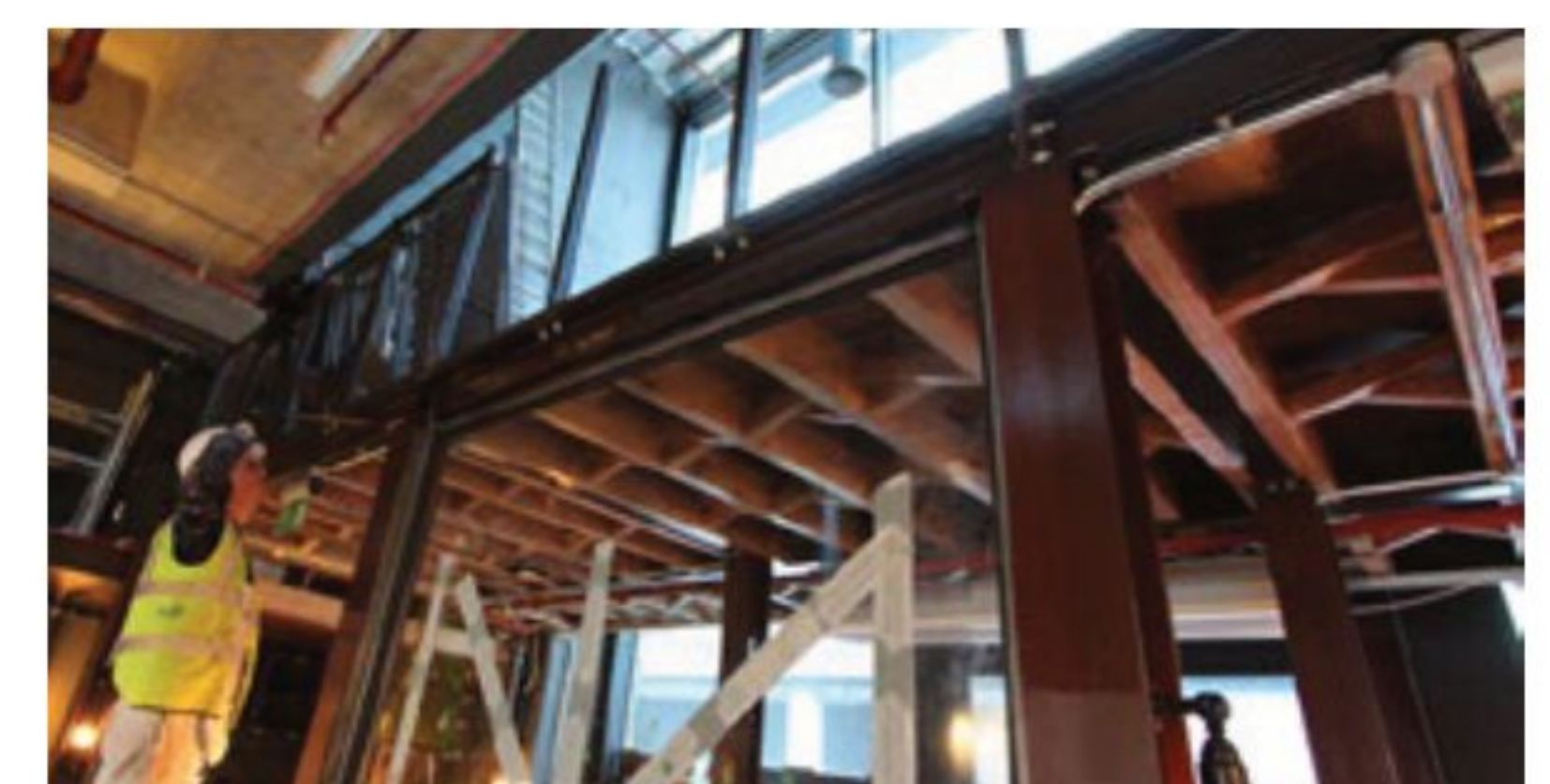

Product 83 - Intumescent coating for steel for upto 90 minutes protection to structural steel. Ideal for Internal and External use.



The Catalonia Institute of Construction



آموزشگاه انعکاس منبع جدیدترین اطلاعات، مقالات و دوره‌های آموزشی دکوراسیون داخلی

Enekas.Academy

Enekas.Academy



UNION PARK DATA CENTRE

A DIGITAL UPDATE FOR HAYES

Bruceshaw has been appointed by Ark Data Centres as Project Manager and Cost Manager on its Union Park project, a new data centre campus on the Bull's Bridge Industrial Estate in Hayes, London.

With consumers, businesses and the public sector becoming increasingly reliant on the digital economy, the demand for data centres continues to grow. The project promises to use the latest sustainable technology and invest substantially in ecological improvements to deliver a scheme which responds efficiently to the needs of Hillingdon Council and its residents.

Fulfilling the sustainability goal will consist of onsite solar generation, air cooling for IT equipment, rainwater harvesting to minimize water taken from the mains, a "living" roof and walls, and electric car charging points.

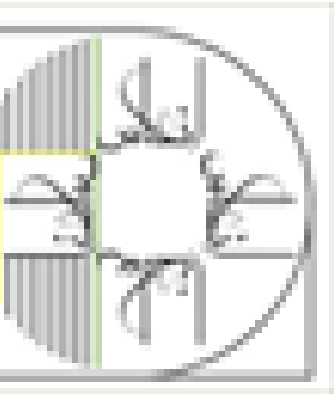
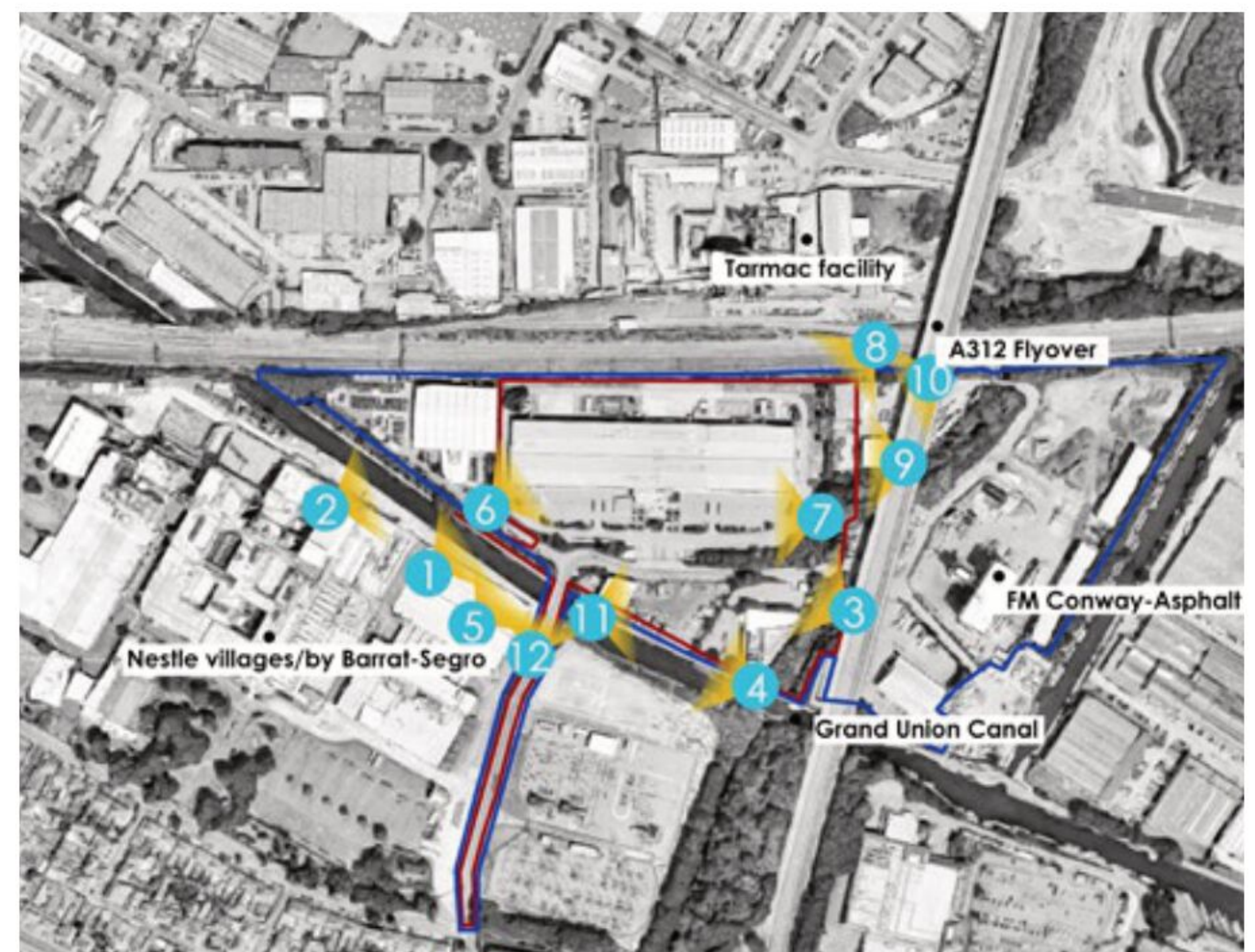

“

With consumers, businesses and the public sector becoming increasingly reliant on the digital economy, the demand for data centres continues to grow.

This will successfully reduce the environmental impact of the facility, reduce the carbon footprint, and help contribute to the government goal of a zero-carbon economy by 2030.

The main power source to the data centre will be supplied directly from National Grid via Ark's new 150MVA substation which will be energized in summer 2021. The data centre will then be provided with 100 percent renewable energy.

In the event of a mains power failure, gas generators will provide backup power, a cleaner alternative to diesel. The Union Park facility will be the first data centre of its size in the country to no longer depend on diesel backup generators, producing a dramatic reduction in emissions.

The Principal Team on the initiative are:

Client: Ark Data Centres

Project Manager: Bruceshaw

Cost Manager: Bruceshaw

Lead Designer: HDR | Hurley Palmer Flatt

Architect: NWA

Planning Consultant: Savills

Landscape Architect: Barry Chinn Associates

www.bruceshaw.com

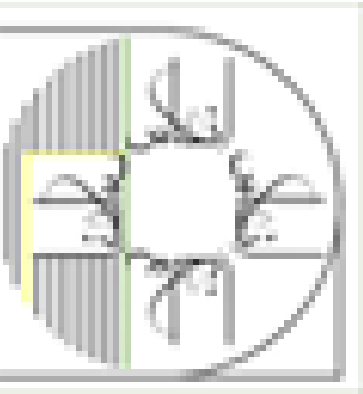

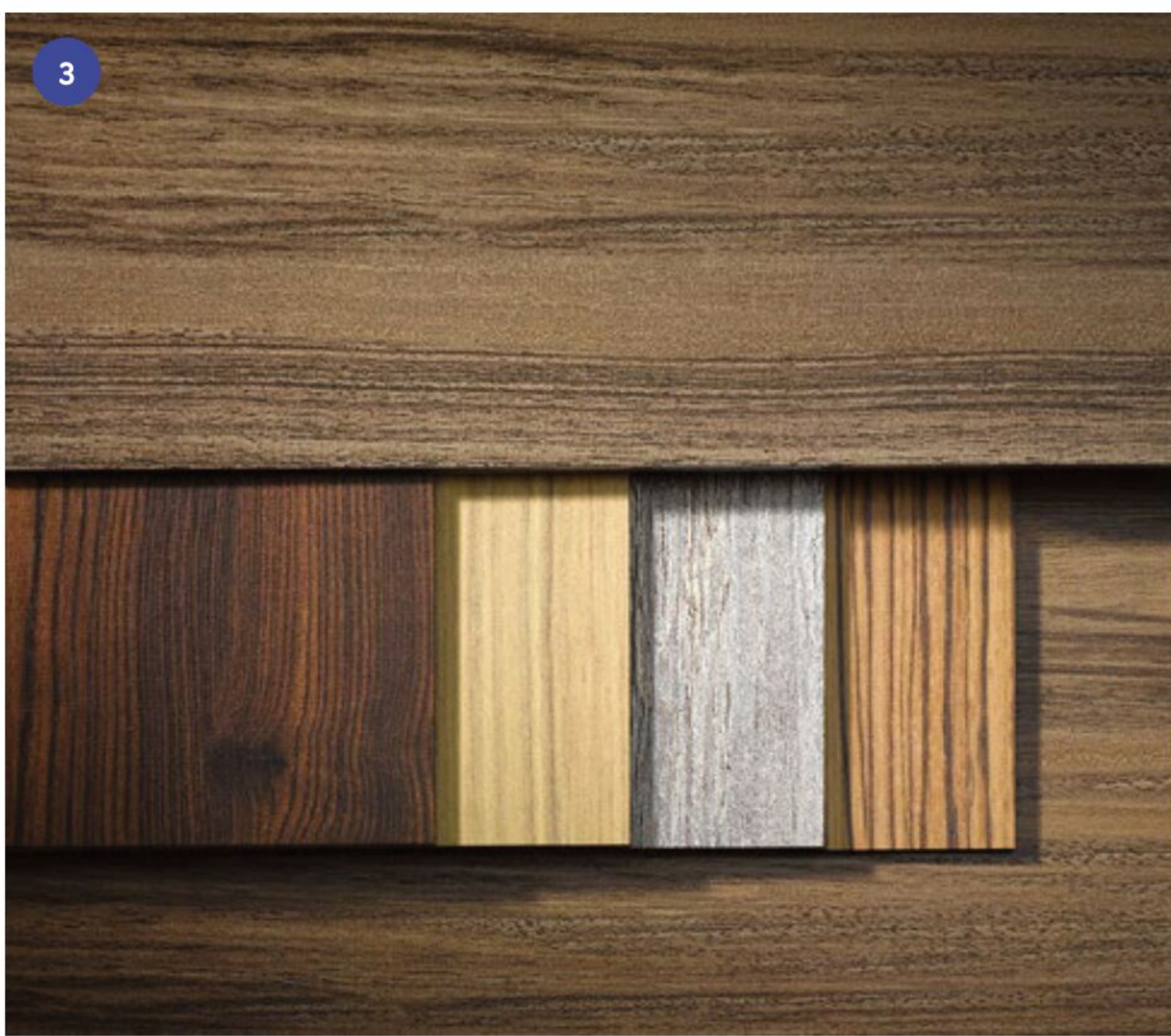

1

CHANGING THE FACE OF FACADES: MILLBOARD LAUNCHES GROUND-BREAKING CLADDING COLLECTION

Millboard has recently launched a suite of cutting-edge cladding materials that confirm the company's reputation as one of Britain's leading home and garden material manufacturers.

In its thirteen-year history, Millboard has continually broken new ground, notably for its flagship UV, split, rot and slip-resistant decking product that has been used in prestigious builds the world over.

The new range of cladding takes its cue from the first-rate attributes of the decking range. Available in two styles and a wide range of colours, it provides the same assurance of UV resistance and eliminates the risk of warping, twisting and rotting.

024 7643 9943
enquiries@millboard.co.uk

2

ART DESIGNED FOR ARCHITECTURE

Unique pieces to fit your bespoke style and space. Colour matched, made to measure, echoing your design to enhance its ambience - art work created individually for you - appreciating in value over time.

Contact Dawn personally to discuss requirements. Whether your taste is fine art realism, deep abstract or 3D, Sculpture, murals exterior and interior. From portraiture to ponds - all artistic aspects of design are considered.

www.dawnpretty.com

3

ALUCOBOND® LEGNO – THE LOOK & FEEL OF NATURAL WOOD

ALUCOBOND®, from 3A Composites GmbH, is pleased to announce 'ALUCOBOND® legno' a stunning new wood-effect finish, which not only looks like wood but due to its special coating – which adds a grainy structured feel to the surface – has a texture to mimic the feel of natural wood too.

Part of the company's new Super Matt surfaces, ALUCOBOND® legno, is a high-quality new generation textured façade panel, which features the company's stunning new extra matt woodgrain surface, to deliver that authentic and much-in-demand natural wood look.

Available in five stunning wood-effect finishes; African Zebrano; Aged Oak; European Walnut; Antique Pine and Coco Bolo, ALUCOBOND® legno is resistant to mould, fire, and temperature fluctuations.

www.alucobond.com

4

RK DOOR SYSTEMS LTD

High Specification entrance door specialist, RK Door Systems Ltd continue to expand and have recently doubled the size of its showroom in Hoddesdon, Hertfordshire. The showroom now has 30 entrance doors on display including 12 Pivot doors with more to follow. RK have a further 3 showrooms in Truro, Crawley and Swindon and have also been establishing a network of displaying dealers in the UK and Ireland to make it easier for their customers to see the many designs and choices that are available. There is an unrivalled range of finishes from a standard powder coat finish through to bonded glass, ceramic, timber effect and their ELITE range of hand applied metal finishes including antique textured bronze and copper. Using the same German profile and components, all RK doors are manufactured in the same purpose-built factory and all doors have PAS24:2016 and Secured By Design accreditation as standard.

www.rkdoorsystems.co.uk

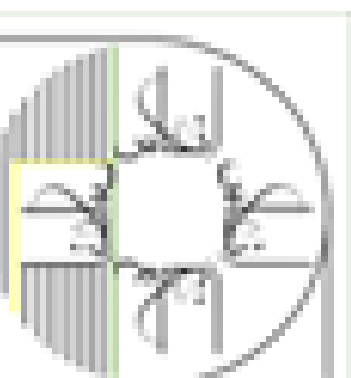
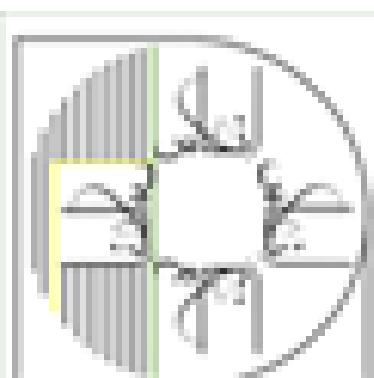

5



6



7



8



5

DERBYSHIRE SPECIALIST AGGREGATES - DALTEX RESIN BOUND

Derbyshire Specialist Aggregates, the manufacturer of DALTEX - the UK's No.1 brand in resin bound - has expanded its resin bound aggregates colour range. Responding to continuing consumer desire for shades of silver and grey, the company has launched Ocean Grey and Gunmetal Grey to add to its comprehensive range of colours. The popularity of resin bound driveways, paths and patios has rapidly increased over the last 5 years and the range of colours available - from greys to blacks, golds to creams, reds to greens is designed to suit every style of property - be it traditional or contemporary; residential or commercial. The Daltext UVR Resin Bound System is SUDS compliant and approved by the BBA - the highest industry standard available for resin bound materials.

Visit: resinbondedaggregates.com
Call: 01629 636500
Email: sales@derbyaggs.com

6

AIR PURIFICATION SYSTEMS FROM DDC DOLPHIN

UVMATIC® air purification units are the latest in DDC Dolphin's range of infection control products. The UVMATIC® and UVMATIC® Plus are the perfect solution, removing harmful bacteria on hard surfaces and in the air, and eliminating odour. Completely automated and chemical free, the UVMATIC® and UVMATIC® Plus draw in polluted air and treats it using UV light and photocatalytic oxidation. This powerful but eco-friendly technology doesn't merely filter out micro-organisms - it destroys them! Proven to destroy viruses such as influenza and coronavirus as well as E.coli, salmonella and similar bacteria, the UVMATIC® and UVMATIC® Plus are highly effective in removing unpleasant smells, killing bacteria that cause malodours, and improving hygiene, leaving rooms smelling fresh and clean.

Tel: 01202 731555
Email: info@ddcdolphin.com
Web: www.ddcdolphin.com

7

COMBINING DESIGN AND DURABILITY

2tec2 is a family owned company specialized in woven vinyl flooring for workspaces, hospitality, healthcare, public space and retail. A 100 % Belgian brand combining design and durability.

This multifunctional flooring combines the best characteristics of both hard and soft surface flooring, creating an innovative contemporary looking floor with endless design possibilities.

The numerous benefits have led us to becoming one of the market leaders in Europe and the rest of the world.

Mark Kayembe
mark@2tec2.com
+44 75 87 37 42 97

8

J&P BALCON®

Insulated Steel Balcony Connection System offers easy balcony positioning tolerance with excellent load capacity. Thermal insulation performance to meet part L.

- Designed for your specific balcony to concrete connection
- Cost-effective, high quality components
- Excellent thermal insulating properties
- Easy to set into position with no need to cut edge shutter
- High load performance with fast installation
- Very low deflection at the connection to the structure
- Now an approved LABC Registered Detail.

For more information and engineering advice please contact J&P Building Systems Ltd.

www.jp-uk.com



9

BARRISOL® NORMALU®

Barrisol® Normalu® is the world leader in stretched ceilings, offering solutions for both ceilings and walls in acoustic, luminous, print, 3D & climatization. Its range of products can enhance any space, which highlight Barrisol's expertise and pioneering approach. Innovation, aesthetics, quality, and preservation of the environment are Barrisol's key priorities, and those of all its employees and partners. The Barrisol Clim® is a climatization system through the ceiling itself, in a silent, invisible and uniform manner, the ceiling can also be luminous, acoustic and printed. The inclusion of air sterilisation, Barrisol Clim offers a fully functional ceiling system with unrivalled comfort, achieving AAA ratings for both cool and warm comfort in accordance with ISO 7730. Environmentally friendly, this system is made with 70% recycled materials. The Biosourcée® membranes and aluminium profiles are also 100% recyclable.

www.barrisol.com/uk

10

OMNIE'S MVHR SYSTEMS AT HEART OF SUSTAINABLE COTSWOLD DEVELOPMENT

The timeless appeal of the Cotswolds' honey coloured stone has been redefined by a bespoke development creating two new homes in the beautiful village of Long Compton, where OMNIE has provided building services packages featuring heat recovery ventilation and renewable heating. The brace of luxury four-bedroom properties has been developed by locally based DG Carpenter on land adjoining an existing bungalow, using a stock of reclaimed Cotswold stone that the building company had stockpiled over a period of years: giving the project an authentic appearance not possible with reconstituted masonry products. Within the past year OMNIE has also revised its range of Smart controls, which include room thermostats and a phone app, offering occupants whole-house control for optimum energy saving and comfort.

www.omnie.co.uk

11

MARBLE-EFFECT SURFACES FROM RADIENZ

The detailed marble-effect surfaces from premium quartz surface brand, Radianz, offer homeowners and designers a variety of elegant choices. Cleverly designed to deliver both aesthetically pleasing and practical surfaces for use in the kitchen and bathroom, each colour and pattern variation has been meticulously considered to ensure a stylish focal point is achieved. From surfaces packed with dense veining, to subtle linear forms and the softest whisper of a contour, the variety of marble-effect variations is outstanding. Choose the large, bold veining of Rio for a striking surface designed to make a statement, or opt for the finite details of Juniper for a delicate addition to the home. The non-porous, high-density composite surfaces from Radianz provide the refined look and feel of natural stone, with added practical benefits. Radianz is also extremely durable, hard-wearing and easy to clean, providing the perfect surface for kitchens and bathrooms.

www.radianz-quartz.com

12

TORC POTS

Torc Pots offers a wide range of distinctive, durable and bespoke statement pieces for outdoor/ indoor areas both residential and commercial.

They work from their studio in the British Isles making pots and furniture which can be custom designed to suit your requirements.

Their pots are shaped by hand until they take on their own unique form - no two pots are ever quite the same.

When we are surrounded by so much that is mass produced we think there is a real appreciation for hand-crafted objects and Torc offer exactly that!

With lots of new launches planned for 2021 including contemporary water bowls of up to 2m wide and a new organic range of pots there is a lot to look forward to.

nicole@torcpots.com



13

OBJECT CAMPUS – CITY OF VISION

OBJECT CARPET turns visions into reality. Their new headquarters will impress visitors with state-of-the-art architecture oriented on sustainability and networking.

For carpet specialist OBJECT CARPET innovation is a key, and not just when it comes to textile floor coverings. The latest example of this is the new company headquarters "OBJECT CAMPUS – City of Vision" in Denkendorf near Stuttgart: impressive architecture with a light-absorbing façade made of aluminium and glass, five floors and an ambitious interior, designed by the Hank + Hirth architects. Openness, great design, high quality standards and collaborations with visionary architecture and design offices is the recipe for success that has earned the company a top position among international carpet manufacturers.

info@object-carpet.com
www.object-carpet.com

14

PILOT GROUP

Perfect for residential and commercial installations, the Pilot Group Lite and Classic EV chargers are sleek in design and usability. Whether the need is convenient and efficient home charging or workplace and commercial applications, our adaptable unit can include a cashless payment system allowing users to pay for charging via methods such as Google and Apple Pay.

Pilot Group offer a full turn-key solution including supply through to full installation and maintenance services. Units are managed through a smartphone app or charge point management and reporting suite, providing powerful capabilities for every level of operation. We are excited to help with all your e-mobility needs.

Pilot Group
evsales@thepilotgroup.co.uk
01606 59 66 22

www.thepilotgroup.co.uk/services/
electric-vehicle-charging-points/

15

THE ADEK EVOLUTION

Originally unveiled at the beginning of the year, the Adek Balcony and Terrace system from Ecodek has evolved and now features a 147mm board to provide further flexibility for smaller refurbishment projects.

This lightweight, A2FL S1 fire rated aluminium decking system meets all the safety requirements for high rise balconies, roof terraces and walkways and is simple to fit, either on-site or off-site. Manufactured from 100% recycled aluminium with a durable coating that provides both excellent slip and wear resistance means the system easily stands up to the rigours of everyday living.

Further information about Adek can be found at <https://ecodek.co.uk/adek-non-combustible-aluminium-decking-system/> or by calling 01978 667 840.

16

BESPOKE SOLUTIONS FOR COMMERCIAL AND RESIDENTIAL PROJECTS

With over 50 years' experience providing bespoke solutions for both commercial and residential buildings, Clyde's solution based approach is designed to ensure we supply the ideal specification for any commercial or residential requirement. Previous projects have included commercial, heritage, healthcare and educational environments, involving a range of heating products; Multi Column, Cast Iron, LSTs, Trench heating and Aluminium radiators, as well as a range of Compact Panel Radiators. Our team will discuss your project including the calculation of heat output requirements (from drawings where required), arrange a full quotation based on your exact project specifications and provide clearly defined lead times in-line with your project timescales. Clyde is a brand of IRSAP, Italy's leading manufacturer of design led radiators.

www.clyderadiators.co.uk

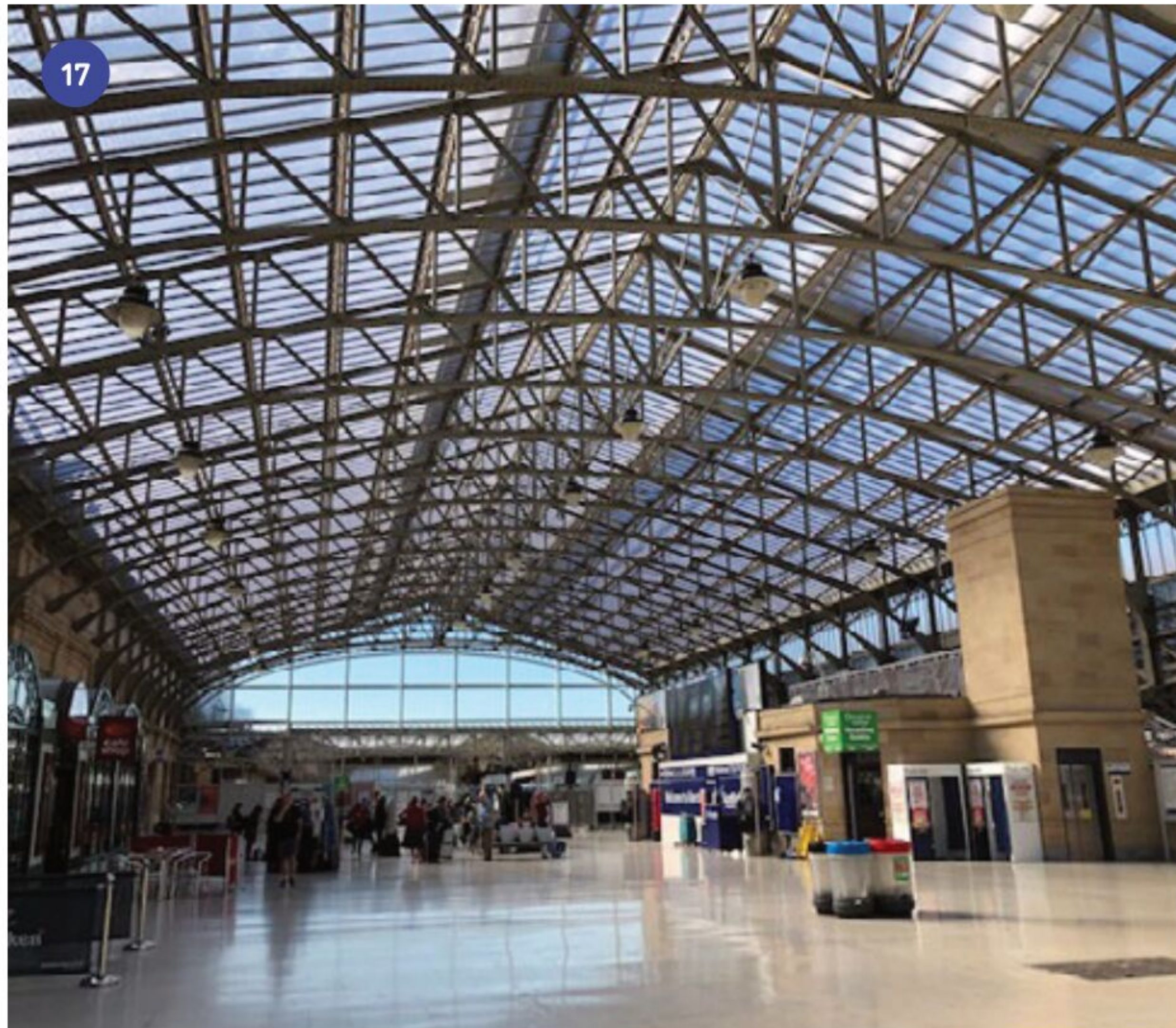

17



18



19



20

CTD
ARCHITECTURAL
—TILES—

17

MULTI-LINK-PANEL NON-FRAGILE

The Multi-Link-Panel NF is an aluminium framed modular rooflight system designed with a unique 'fix and link' fixing method that results in incredibly quick installation.

The panels are non-fragile to ACR[M]001:2014 and available with different polycarbonate glazing variations, from clear solid (offering a glass-like appearance) to Georgian wired and multi-wall options.

The Multi-Link-Panel system features the following benefits:

- Fast installation
- Non-Fragile
- Recyclable
- Long lasting and durable glazing
- Lightweight
- Modular pre-assembled panels
- UV coated polycarbonate
- Virtually unbreakable polycarbonate

www.twinfix.co.uk

18

SWA MEMBER TRANSFORMS THE JAM FACTORY, OXFORD

The Jam Factory in Oxford, once home to Frank Cooper's marmalade business, now comprises over 1,000 square metres of modern office space and a separate café and art gallery. Located in the heart of the city close to Oxford train station, this Grade II-listed building has undergone impressive renovation and refurbishment work to refresh its grand appearance and create the new office space. Member of the Steel Window Association, Cotswold Casements, has extensive experience in the repair, replacement and refurbishment of windows and was tasked with the responsibility of the fenestration. The Cotswolds-based metal window expert refurbished the windows offsite; the detailed work undertaken included a polyester finish applied to the window sections. This was an impressive project taking around a year to complete and the reinstallation of over 100 refurbished windows has created a striking result.

www.steel-window-association.co.uk

19

CZECH & SPEAKE

Czech & Speake brings a unique approach to bathing products, encompassing fine fragrances, and bathing accoutrements. Instantly recognisable for our definitively English character, and are regularly used in luxury private residences and hotels worldwide.

All products are designed in-house by our original founder Frank Sawkins, with a focus on usability and longevity alongside exquisite design. With three core collections and a range of finishes, including bespoke options, our products are suitable for traditional and modern clients alike.

Our flagship showroom on the infamous Pimlico Road is the perfect opportunity to view our products in person, alternatively please visit our website for further information.

sales@czechandspeake.com
+44 208 7839400

www.czechandspeake.com

20

THE NEW NIZA TILE COLLECTION FROM CTD ARCHITECTURAL TILES

Inspired by the colours of the earth and the ocean, Niza is a collection of rectangular and hexagonal tiles in an understated nature-inspired palette. From the warmth of Clay to the freshness of Green, the various tiles come with a gentle shade variation that reflects the essence of traditional ceramic tiles, bringing a modern touch to this cutting-edge product range. Available in a rectangular 92 x 370mm and a hexagonal 215 x 250mm format, the versatile cement-effect tiles will add an injection of character to both walls and floors in all residential, commercial and hospitality projects. With a +36 PTV wet slip resistance, the matt glazed porcelain tiles deliver on both technical and aesthetic properties, allowing specifiers, architects and designers to bring subtle texture and warmth to surfaces, whether used in bathrooms, kitchens or living spaces.

www.ctdarchitecturaltiles.co.uk

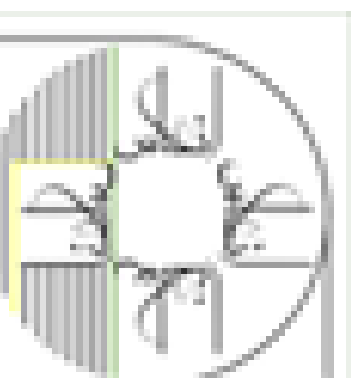
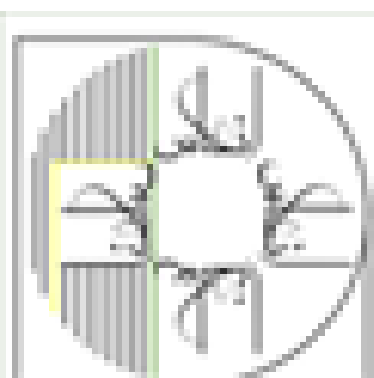



21



22



23



24

21

WHY STERLINGOSB ZERO?

Norbord's portfolio of OSB products is one of the most popular in the building and interior design industries and comprises SterlingOSB Zero OSB3, SterlingOSB Zero Tongue and Groove, SterlingOSB Zero Fire Solutions and SterlingOSB Zero StrongFix. They are variants of the precision-engineered OSB3 board; BBA-approved and designed for humid conditions, the board contains zero added formaldehyde and is unique in the market by being the only ZAF OSB manufactured in the UK. Produced in Scotland from forest thinnings taken from sustainably managed forests, the board is certified according to the guidelines of the FSC or PEFC.

The SterlingOSB Zero family from Norbord uses a formaldehyde free resin system to bind the thousands of strands that make up each board.

For further information, call 01786 812 921 or visit www.norbord.co.uk.

22

COMBAT COVID-19 WITH PUREAIR

Create a safe workspace with the PureAir R150 professional air cleaner. It is now widely accepted that COVID-19 is transmitted in enclosed indoor spaces where a staggering 90% of our time is spent and even more in winter. Businesses must start considering more effective ways to improve IAQ, provide a clean, safe working environment and peace of mind for staff and customers.

Safe air should be an integral part of our coronavirus precautions as viruses attach themselves to airborne pollutants which leads to them remaining suspended in breathable air for up to 3 hours and able to travel further distances.

For more on the PureAir with H14 filters and UVC sterilization, contact: Loretta King, Alert Technology Ltd, loretta@asbestos-alert.com www.alerttechnologyltd.com

23

ADVANCED PERIMETER SYSTEMS

Perimeter security has never been more important whether at home or at work. Advanced Perimeter Systems range of perimeter security systems provide solutions for every security challenge.

Our solutions are quality assured, proven, reliable, robust and simple to install. Whatever challenges you face securing your property why not give us a call to discuss your needs we may be able to design a bespoke solution just for you.

Advanced Perimeter Systems has a reputation as a manufacturer and designer of high quality, high security, perimeter security solutions. We have a range of products available for installation to make any premises more secure from industrial, commercial to domestic property.

Email: sales@apsltd.net
Tel: 01786 479862
www.advancedperimetersystems.com

24

LED LUKS

LED Luks is a European manufacturer of commercial and architectural LED luminaires, which are used in some of the most elegant and striking designs across the world. Located on the border between Slovenia and Italy, LED Luks combines the best of both cultures, marrying together Slovenia's innovative business spirit and diligence with the Italian tradition in industrial manufacturing and design expertise. The synergies of both cultures and working traditional industries support the customer-focused philosophy, as well as the company's commitment to providing products that are of a truly high quality. The company wishes to be a reliable partner for representatives, lighting designers, architects, installers, specifiers, and other creators in lighting industry. With its number of standard product lines, it offers LED luminaires for offices, educational facilities, public buildings, restaurants, hospitality venues, and exhibition areas, as well as industrial, sports, and events halls.

+386 (5) 393 24 77
info@ledluks.com



OIZ OFFICE

The Architizer A+ Awards is the largest awards program focused on promoting and celebrating the year's best architecture and products and one was won by Yazgan Design with its project OIZ Office. Its mission is to nurture the appreciation of meaningful design in the world and champion its potential for a positive impact on everyday life. Imagine your best work in front of a global audience of 400+ million.

With this addition to their list of awards and accolades, Yazgan Design continues to show its commitment to design innovation and strives to expand its presence both locally and globally by delivering exceptional design ideas and solutions to their clients.

OIZ OFFICE

OIZ Office serves for the Aerospace Specialized Organized Industrial Zone's administrative personnel and board of directors, in Ankara, Turkey.

What generates the design and organizes the program is the idea of integrating nature into the work environment. Therefore, the spaces are arranged in programmatic clusters that are integrated with inner gardens. The gardens make sure that natural light reaches every corner within the building, blurring the distinction between inside and outside in a way. Each office table has an inner garden on one edge. While separated physically with horizontal inner gardens, thus achieving ideal dimensions and clear divisions for different functions; visual continuity is maintained through transparency.

A dynamic interior is achieved through including nature into design. The effect of the seasonal changes can be observed in many different ways like the illumination of the snow into the interior or the ever-changing shadows of the trees in a day. The courtyards also ensure natural ventilation in the building.

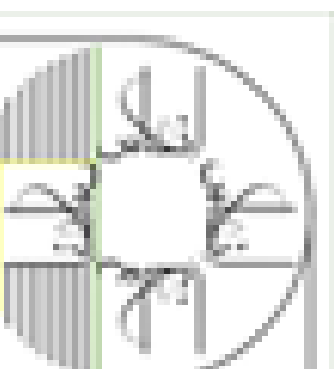
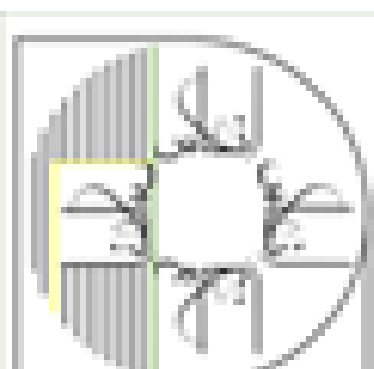



“

A dynamic interior is achieved through including nature into design.

The clusters are organized as such: conference hall and meeting hall cluster, a cluster of offices for different departments, VIP rooms cluster, and cafeteria cluster. The depth of the clusters is utilized in such a way that the areas that do not require natural light, such as services and conference hall, are located either at the central core or inner edge in order not to hinder the relationship between the spaces and gardens.

A continuous slab unites the clusters underneath and creates a free-flowing interior plaza that accommodates a small cafe, seating areas, and the foyer of the conference hall.

The structural system of the building has been solved in a design-

oriented manner; the columns and beams that carry the roof are joined as frames so that they can be turned into urban furniture/ seating benches serving the building users.

Technical sheet

Location: Ankara, Turkey

Land Area: 71.287 m²

Client: Ankara Aerospace Specialized Industrial Zone

Project date: 2018-2020

Total Construction Area: 6.293 m²

Total Landscape Area: 63.346 m²

Architecture, Interior and Landscape design: Yazgan Design Architecture

3D Image Credits: Ivabox, Yazgan Design Architecture

Structural Project: TG Project

Mechanical Project: GMD Engineering

Electrical Project: EMP Engineering

www.yazgandesign.com

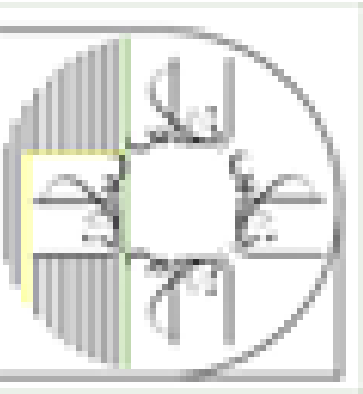

MAKING SPACE

WITH POCKET DOORS



OUR PRE-ASSEMBLED POCKET DOORS ARE FAST AND EASY TO INSTALL

Gaining vital extra space has never been easier than with Scrigno Pocket Doors. Ideal for kitchens, bathrooms or anywhere space is at a premium.

Available in single and double door systems. FD30 fire rated systems and glass door conversion kits are also available. Each pocket is manufactured to the highest standard and comes with a 10-year guarantee.

Visit www.excel-gh.com/scrigno or email sales@excel-gh.com for more information.

ACCESSORIES & FEATURES



AUTO CLOSER AVAILABLE



DAMPER AVAILABLE



10 YEAR MECHANICAL GUARANTEE

THE QUICK FIT POCKET DOOR SYSTEM FROM

SCRIGNO[®]

آموزشگاه انعکاس منبع جدیدترین اطلاعات، مقالات و دوره‌های آموزشی دکوراسیون داخلی

 Enekas.Academy

 Enekas.Academy

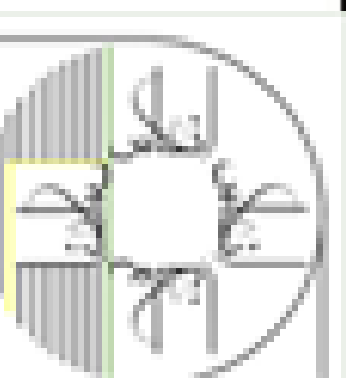
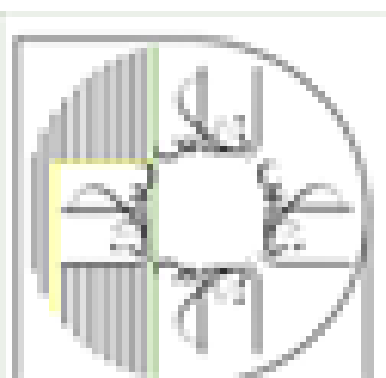



Designer Italian door furniture

Excel is the exclusive distributor of Frascio Designer levers in the UK. All Frascio levers are designed and manufactured in Italy using the latest technology. The expansive range of styles and finishes ensure we can always cater to the latest trends for both domestic and commercial applications.

NEW SPECIAL FINISHES AVAILABLE TO ORDER



Corten



Cotto
Fiorentino



White Soft
Touch



Black Soft
Touch



Leather



Red Copper
Matt



London Night
Matt



London Night
Polished



Grey
Stone

Visit www.excel-ah.com for more info and see the full range of designs



25 YEAR
MECHANICAL
GUARANTEE

frascio[®]
OPEN TO YOUR WORLD

آموزشگاه انعکاس منبع جدیدترین اطلاعات، مقالات و دوره‌های آموزشی دکوراسیون داخلی

Enekas.Academy

Enekas.Academy

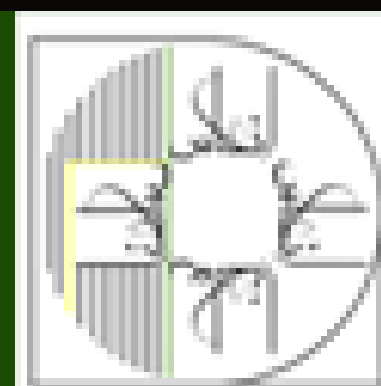
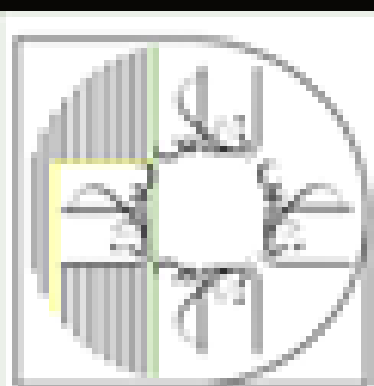

PAREX

A SIKA COMPANY

PAREXTRA

Training, product samples, technical support plus nationwide coverage from a leading render manufacturer.



THE RENDER EXPERTS

Contact your sales advisor to find the Parex difference.

01827 711755

parex.co.uk



آموزشگاه انعکاس منبع جدیدترین اطلاعات، مقالات و دوره‌های آموزشی دکوراسیون داخلی

 Enekas.Academy

 Enekas.Academy

